

Science-between-Myth-and-Truth.com

Volume 2

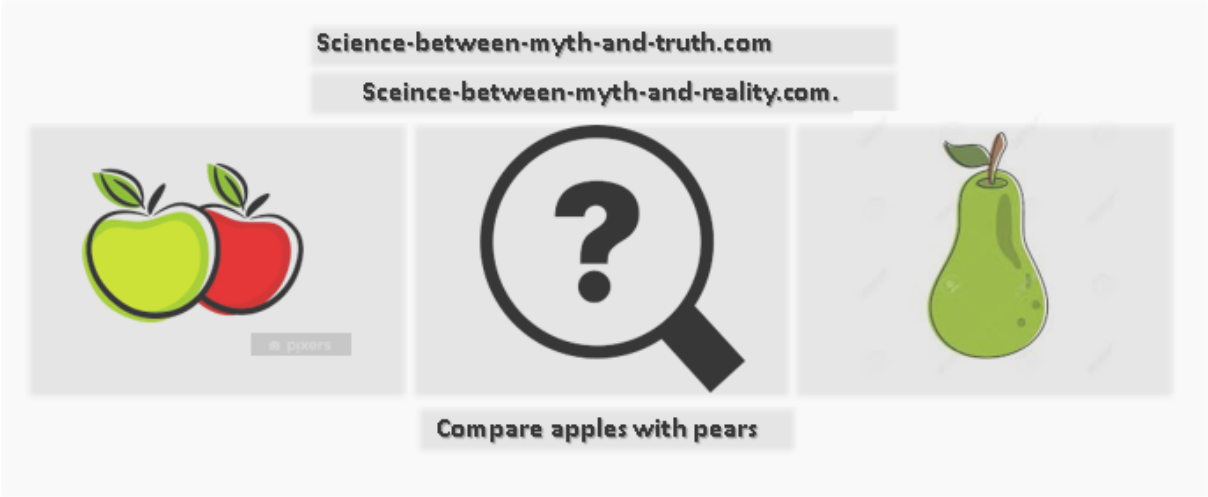

Introduction

A snapshot with regard to current scientific debates is more than necessary. The series "Science between Myth and Truth" aims to bring to light the blind spot of a process of reflection, both subjectively and objectively. In doing so, various topics are taken up in order to counteract the mainstream as well as to deal with the real causes of various problems.

A well-known saying goes: "Only those who swim against the current reach the source". This aptly describes the objective of the essays in the series "Science between Myth and Truth". The series consists of two volumes. The first volume describes two topics, addressing both Covid-19 and scientific interpretations of various topics in the fields of electrical engineering, neurology, religion and politics as well as their impact on society.

It is always important not to compare apples with pears. The second volume covers topics in astrophysics and explores the story of creation to clearly highlight why many things have gone wrong in science.

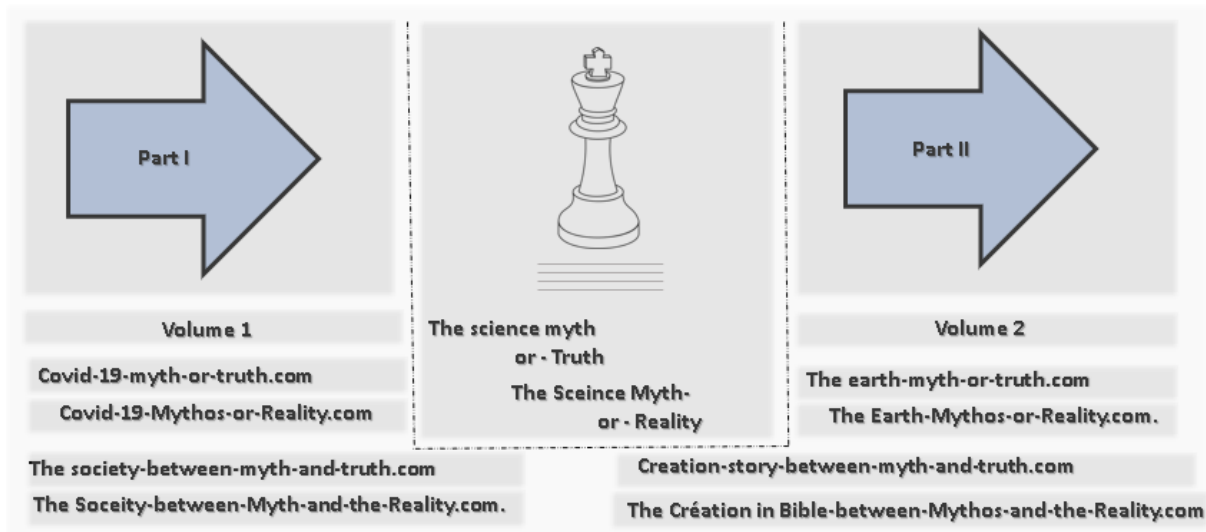

This article is part of that series. This second volume deals with two topics. The first topic is *Earth - myth or truth?* although there will be some arguments against a biological solution to the Covid-19 pandemic. The article deals with physics and especially astrophysics from the perspective of an electrical engineer. This article is also available online as a blog.

Foreword and structure of the essay

This essay deals with two topics. The figure "Structure of the essay" shows these two topics.

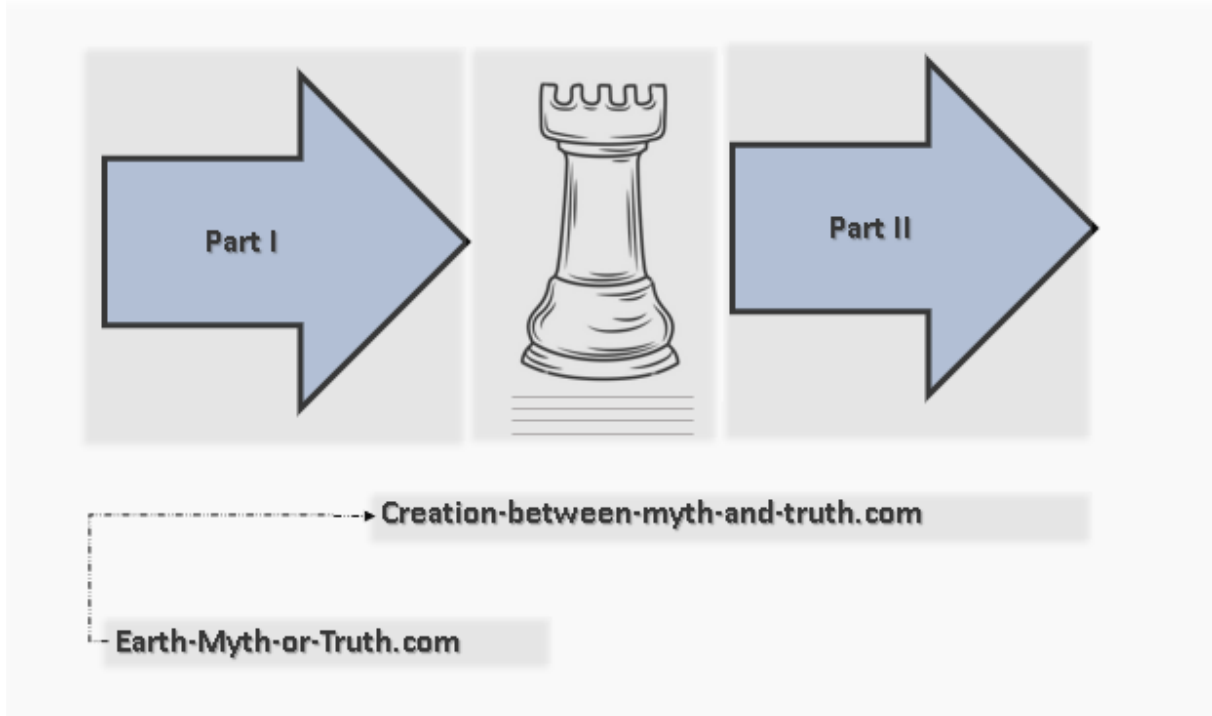

Figure 1: Structure of the essay. Source: own illustration

This second volume deals with two topics. The first topic is Earth - *myth or truth?* with some arguments against a biological solution to the Covid-19 pandemic. The article deals with physics and especially astrophysics from the perspective of an electrical engineer. This article is also available online as a blog. In this post, the Covid-19 pandemic is based on a physical cause, which should be addressed by a physical solution, and not by biology and the code of life. The second topic is *Creation – Myth or Truth?* The focus is on the creation story, which deals with the emergence of the earth and mankind as part of the universe. In this way, society should be made aware of the time zero in the history of its origin.

This article is based on a physical cause of the Covid-19 pandemic, which should be countered by a physical solution and not by biology and the code of life. The second topic in this article is *Creation – Myth or Truth?* The focus is on the creation story, which deals with the emergence of the earth and mankind as part of the universe. In this way, society should be made aware of the time zero in the history of its origin.

This article aims to deal with certain topics that are intended to contribute to conducting scientific discussions in a more objective, simpler and better way, in order to internalize the information and knowledge in various media channels in a more conscious and rational manner. On the one hand, hypotheses are put forward that are not considered in scientific publications as they are new from the point of view of the author of the article.

On the other hand, questions are addressed that are currently necessary in order to gain a better understanding of the universe as well as the history of creation and the evolution of mankind. As a result, the publications in astrophysics can be understood and read from a different perspective.

A target audience for this article cannot be determined. However, knowledge of university or high school is sufficient to be able to understand the analysis, interpretation and critical examination of the present article. Nevertheless, the topics covered can also be understood as general knowledge in order to be able to sensitize society with regard to the topics covered. At this point, it is important to emphasize that first Volume 1 and then Volume 2 should be read, so as not to lose sight of the big picture.

Table of content

PART I: EARTH-MYTH-OR-TRUTH.COM	6
1. PROBLEM	7
2. QUESTIONS AND TARGETS	8
3. MOTIVATION OF THE ESSAY	10
4. SCIENTIFIC DISCOURSES OF THE PRESENT WORK	12
1.1. Electrical engineering with Einstein and Max Planck.....	12
1.2. Infrasound and Einstein's world formula	14
1.3. The earth's orbit every 120 years.....	15
1.4. Splitting of matter through infrasonic waves	16
1.5. CO2-increase during the Covid-19 crisis	21
5. SUMMARY AND CONCLUSION	24
6. CONCLUSION	24
1.6. Credibility of the work.....	24
6.2. Intended uses of the Covid-19 particles and solutions.....	26
TEIL II: THE CREATION-BETWEEN-MYTH-AND-TRUTH.COM	29
1. WHERE IS THE PROBLEM?	30
2. QUESTIONS AND TARGET	30
3. MOTIVATION OF THE ESSAY	32
4. WHAT IS CHRISTIAN CREATION TO NOT TO RELY ON PREGNANCY?	35
5. EXEMPLARY PURPOSES OF CREATION	37
6. SUMMARY AND CONCLUSION	41
7. CONCLUSION	41

Part I: Earth-Myth-or-Truth.com

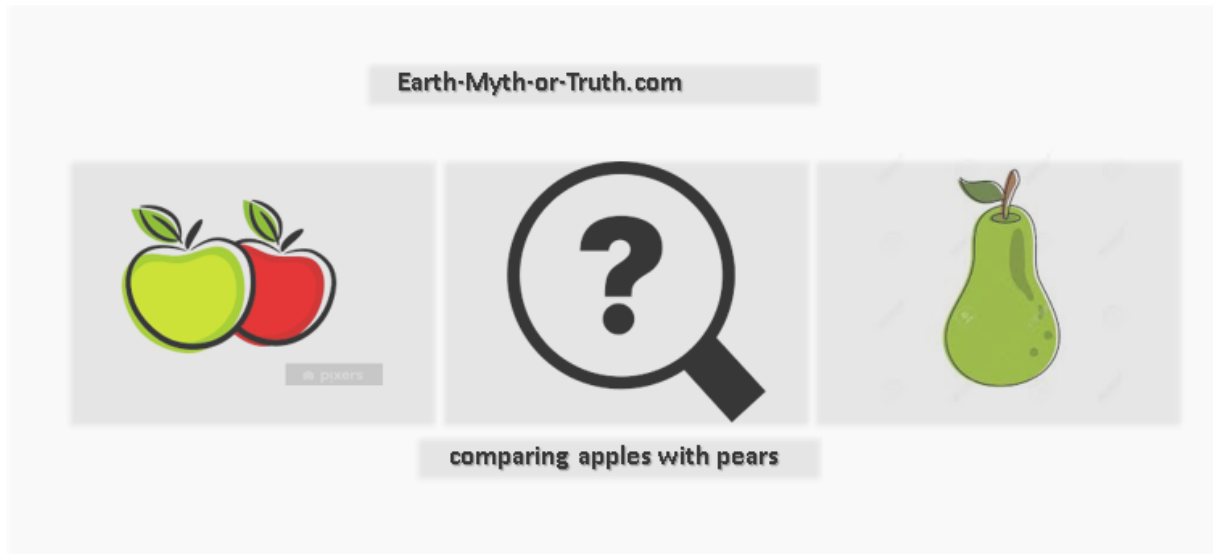

1. Problem

In the first volume of this series, the topic of Covid-19 was considered a physical phenomenon caused by cosmic rays. It is thus reasonable to assume that such findings have long been used in the military industry. The focus here is on the infrasound range, which, however, is difficult to measure. The following two figures symbolically show the history of creation between the traditional and non-traditional and invisible military industry.

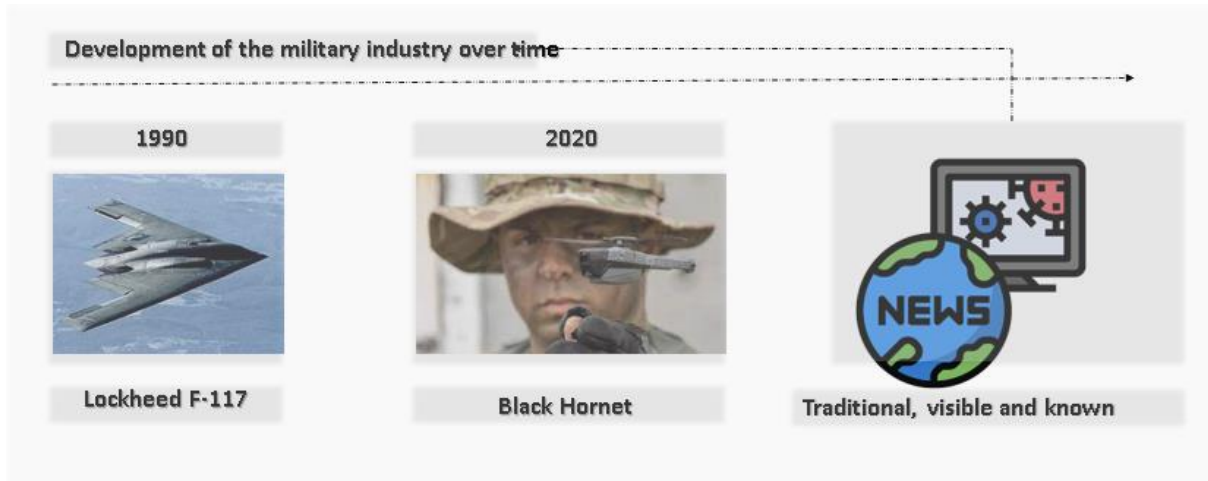

Figure 2: Traditional military industry. Source: own illustration

In Figure 3, attention should be drawn to the apple and the ant, as such techniques address the history of creation.

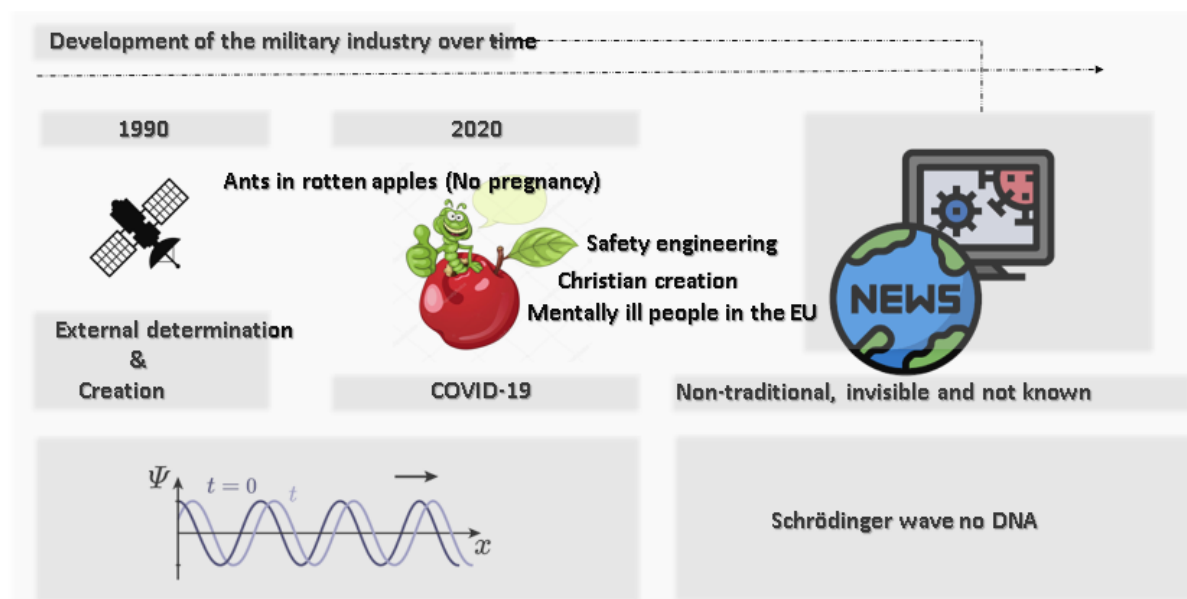

Figure 3: Non-traditional military industry. Source: own illustration

2. Questions and targets

The following questions are dealt with in this work:

1. If humanity is comfortable using the speed of light as a benchmark, then the time of its discovery should not be forgotten at the present time in 2023. We've only been living with such a discovery for 120 years.
2. If an astrophysicist regards the times B.C. as not up to date, i.e., also in this respect the religious traditions, then the idea of an astrophysicist that the universe is expanding and heating up further until it cools down again should be seen as wrong. The first and second volumes of this work deal with the hypothesis that we commute or swing between two points. Just comparing Covid-19 to the Spanish flu 120 years ago should be enough to dismiss these astrophysical facts as an unconfirmed thesis.
3. The present work is based on the following hypothesis: If the Sun exists in the Milky Way as part of the Universe, then this should be considered the only light source for the purpose of the computability problem. Anything else much further away should be considered a side effect, here meaning distant stars.
4. Conversely, if the speed of light is measured in a vacuum, it means that matter or Covid-19 particles cause a vacuum when moving and spreading at the speed of light.
5. In addition to the sun as a unique feature of the Milky Way, this work assumes that since the beginning of the Covid-19 crisis, it has not been the solar radiations that are responsible for the visibility of things on earth, but rather the reflections of the solar radiations on the furthest planets in the Milky Way. We approach the sun in a pendulum motion every 120 years, i.e., solar radiations do not have a full-fledged lambda, which characterizes the magnetic wave in a sunbeam.
6. In a further hypothesis, in addition to considering the sun as the unique feature of the Milky Way, the work assumes that some stars radiate something – not because they are subject to permanent chemical reactions, but because they reflect and reverse the polarity of solar radiations.
7. The cause of the gravitational waves in relation to gravity lies in the fact that radiations are reflected and reversed on masses. Through such reflections in combination with chemical reactions in matter, the solar radiations are polarized negatively, which represents an attraction. This question represents a hypothesis, which is tested by the present work.

8. In frequency technology, the infrasound range with a frequency of one Hertz is to be regarded as a heuristic, which leaves a lot of room for speculation and is difficult to measure. As a result, a lot of wrong things can happen, consciously or unconsciously.
9. In the infrasound range, there are heuristic approaches which the present work considers a hypothesis. In doing so, the work formulates the hypothesis that the magnetic effect in the infrasound range with frequencies below 10 Hz is very large, so that such frequencies reach the earth in 8 minutes, just like solar radiations. This is due to the fact that such frequencies have very large lambdas that spread over millions of light years. The proof of this hypothesis is obvious and states: If this is not true, no ray of light would have reached the earth in 8 minutes.
10. Frequencies in the infrasound range can cause fission in matter. This splits the magnetic parts of an object or living being from the rest. One object becomes 4. As a result, people can be controlled from outside, which is further promoted by tunnel effects as in an atomic level.
11. Covid-19 are particles in the infrasound range, which slip in through the tunnel effect after the splitting of the magnetic part of an object or living being.
12. The developments in atomic clocks in space may result in the generation of exact frequencies in the infrasonic frequency range; and what is valid in space is also possible in mobile phone applications.

The aim of the present work is to examine the above-mentioned questions more closely and to confirm them exploratively and symbolically. A precise investigation through mathematical formulations and simulation through to experimental physics follows in further volumes, which will be written down and made available after the first and second volume of the work "Science between myth or truth".

3. Motivation of the essay

Personal observations throughout life, and specifically during the Covid-19 crisis, provide an intrinsic motivating factor to further explore the interplay between symbolism and the lore from the past and current events, both in science and in the world. From my own point of view, there is an immense linear connection and an exponential interplay between the symbolism of traditions and messages as well as science.

The following two figures show the answer to some questions, e.g., Why are there 9 candles in the symbolism of the Jews and what does that have to do with time? Another question relates to the reason or the research into the causes of the visit of an American actor during the World Cup in Russia and the current situation and the war in Europe.

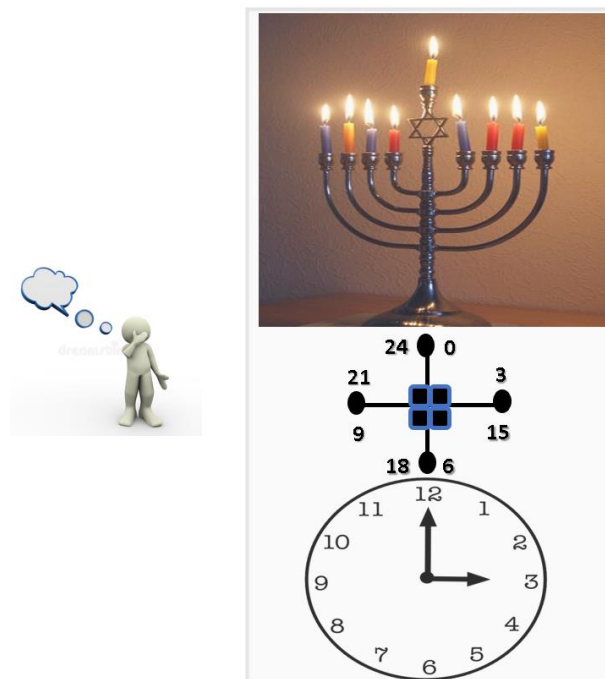

Figure 4: Why do the Jews have 9 candles and what does that have to do with time? Source: own illustration

These symbolism and questions motivated me to write this essay. There is an interplay in it, which requires an investigation into the cause research in order to be able to answer the questions in the present work. Within this context, the Covid-19 crisis and the publications of the current zeitgeist encourage us to get to the bottom of the causes.



Figure 5: What is Aladdin's magic lamp doing in Russia during the World Cup? Source: own illustration

4. Scientific discourses of the present work

The questions of the present work are analyzed and examined so that new findings can be represented compared to the state of the art. The scientific discourse in the following sub-chapters serves to stimulate and to think and rethink in terms of Covid-19 and life on Mother Earth.

1.1. Electrical engineering with Einstein and Max Planck

What Einstein and Max Planck once called electrodynamics is now called electrical engineering and theoretical electrical engineering. An astrophysicist is therefore at a disadvantage if new findings are only dealt with on the basis of astrophysics. Figure 6 is intended to honor the two scientists. The magnetic part of an infrasound has a very high λ , which is millions of light years; otherwise, no ray of light would have reached the earth in 8 minutes. These frequencies travel at the speed of light and even faster, which means they have vast amounts of energy.

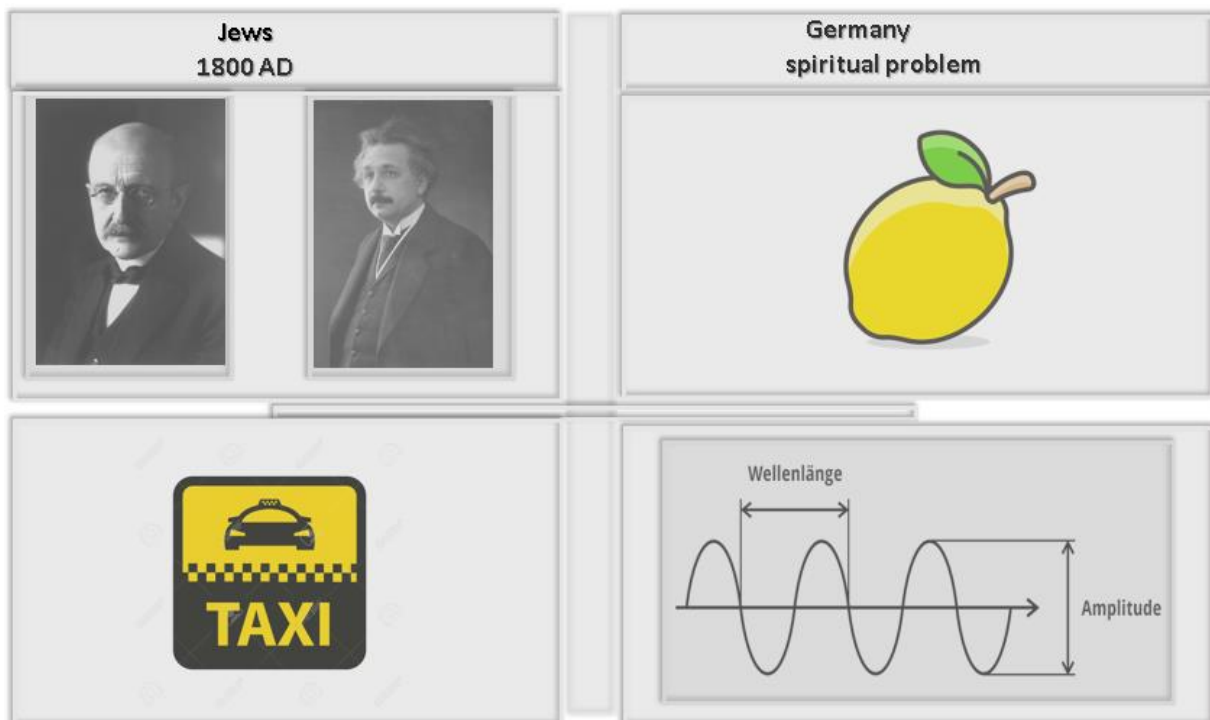

Figure 6: A lemon for power generation but with infrasound in magnetic effects. Source: own illustration

Both characterizing infrasound and measuring its properties is difficult and unpredictable. On the way to the truth, it requires geometric linear algebra and symbolic mathematics on the one hand, and the consideration of the problem in a Cartesian coordinate system, on the other hand, but not the use of polar or spherical coordinates. This is intended to illustrate the investigation of the causes of Covid-19 more clearly.

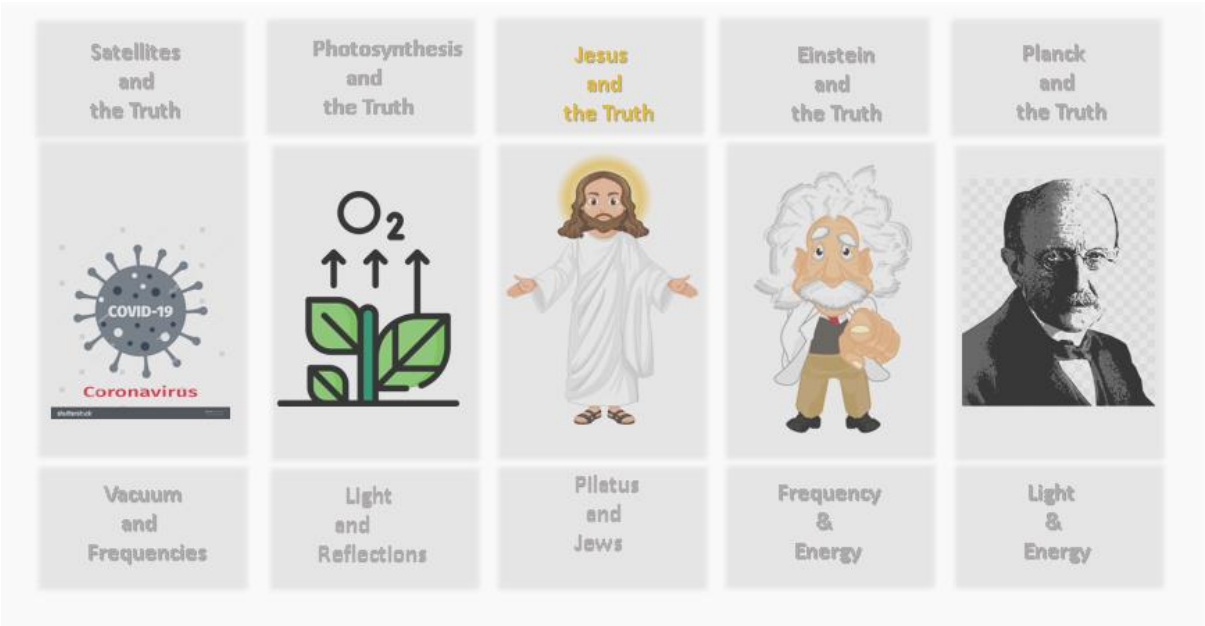

Figure 7: The path to truth requires symbolism and firm belief. Source: own illustration

1.2. Infrasound and Einstein's world formula

The lambda in the infrasonic frequency range has a very large curvature and propagates over large distances and at least at the speed of light. In addition to this fact, Albert Einstein's world formula applies to a frequency that has the reciprocal value of the speed of light. Figure 8 and Figure 9 address the effects of such frequencies.

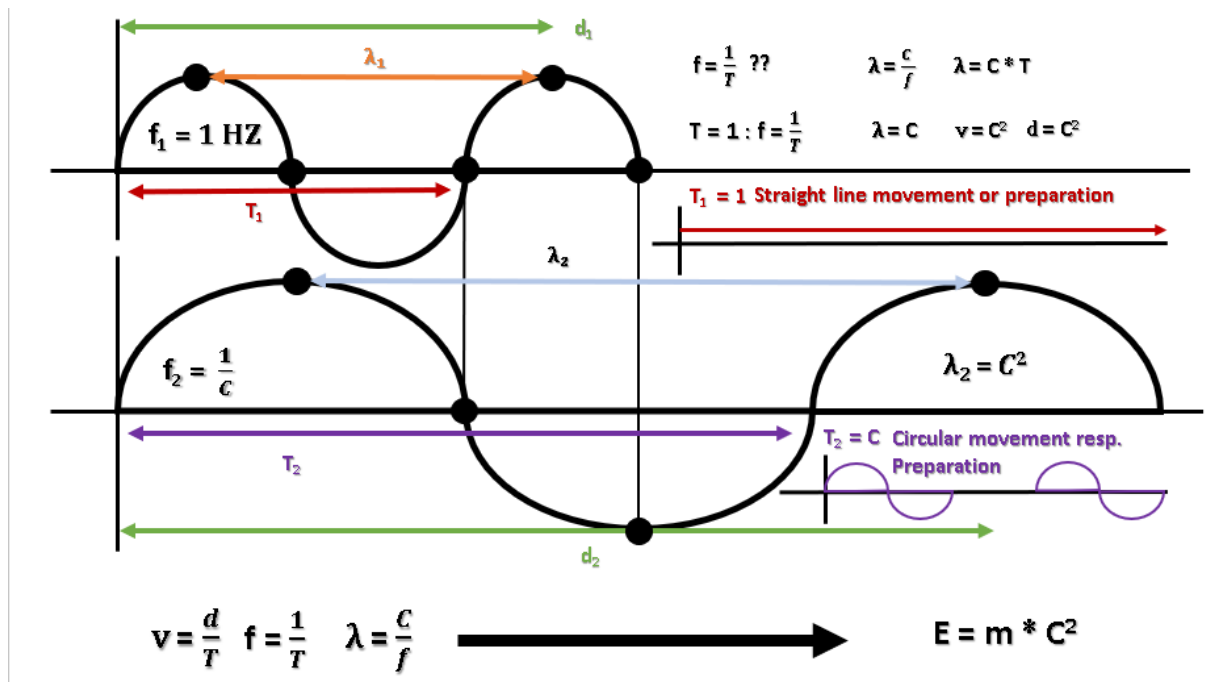

Figure 8: Infrasound as the reciprocal value of the speed of light. Source: own illustration

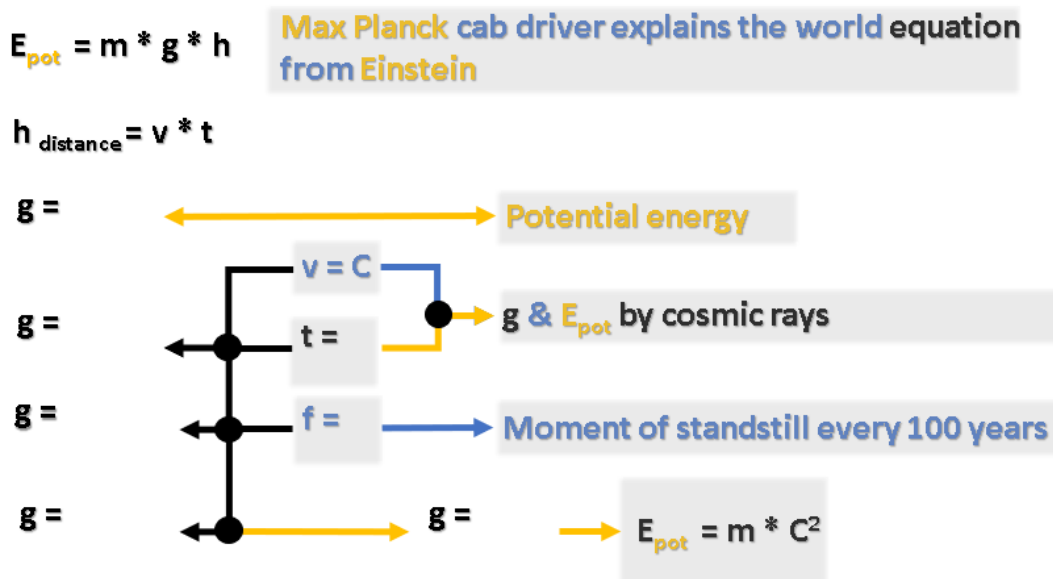

Figure 9: Albert Einstein's world formula. Source: own illustration

1.3. The earth's orbit every 120 years

The symbolic historical dates alongside Covid-19 as an event encourage the notion that the earth hovers between two extremes, namely every 120 years. In doing so, the distance to the sun decreases every 60 years in proportion to the elliptical semiaxis as the earth rotates around the sun.

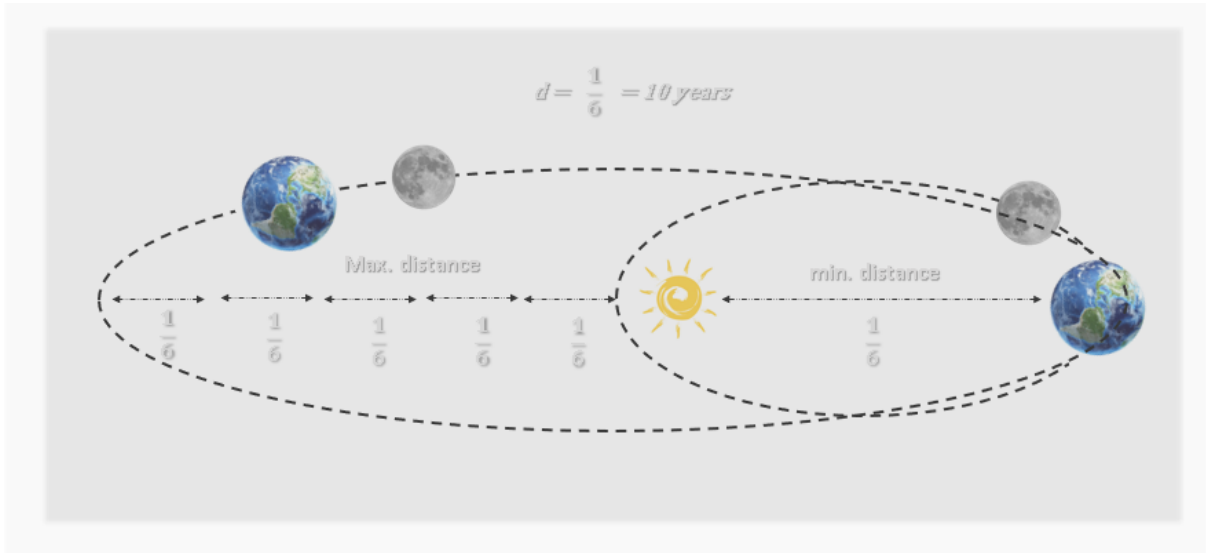

Figure 10: Earth's oscillation between two extremes every 120 years. Source: own illustration

The two extreme points every 60 years in the Milky Way form a bottleneck, which can be clearly shown mathematically in Figure 11.

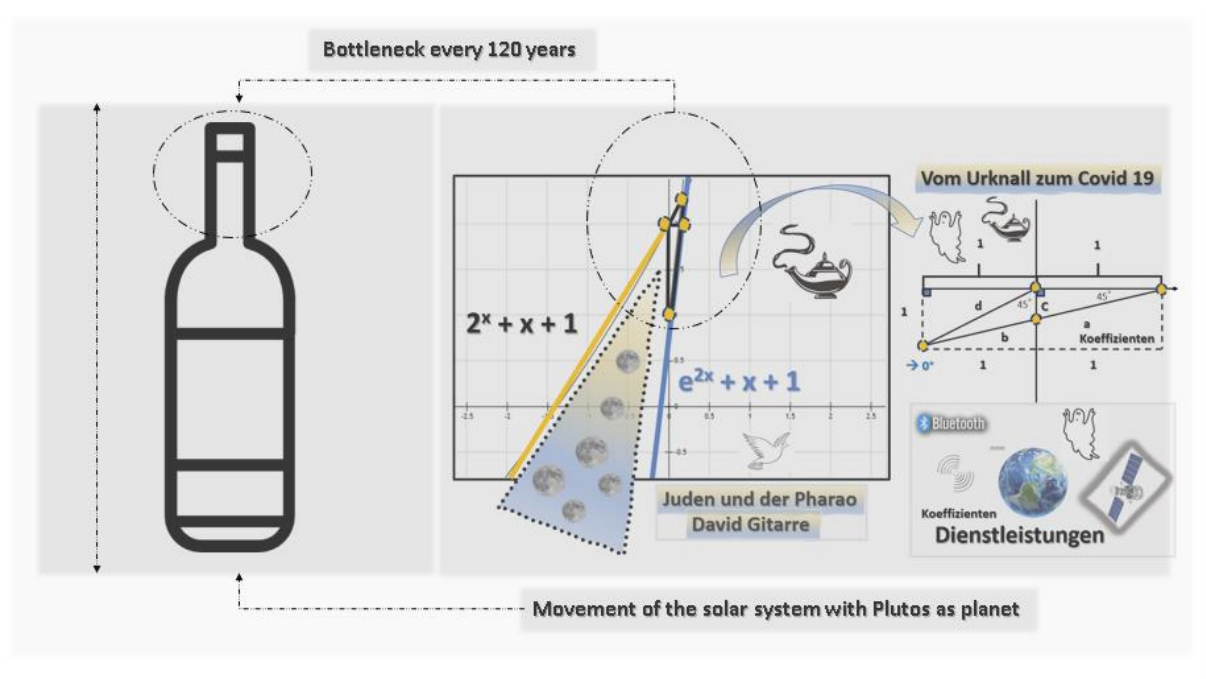

Figure 11: Milky Way bottleneck every 120 years. Source: own illustration

1.4. Splitting of matter through infrasonic waves

Matter is split by the magnetic energy of an infrasound into a so-called alpha splitting, which has a ratio of 1:4. The magnetic part is visibly mirrored as an image of the mass. Own observations have shown that the stars and planets in the solar system quadruple as a result. Figure 12 below shows this using the moon as an example.

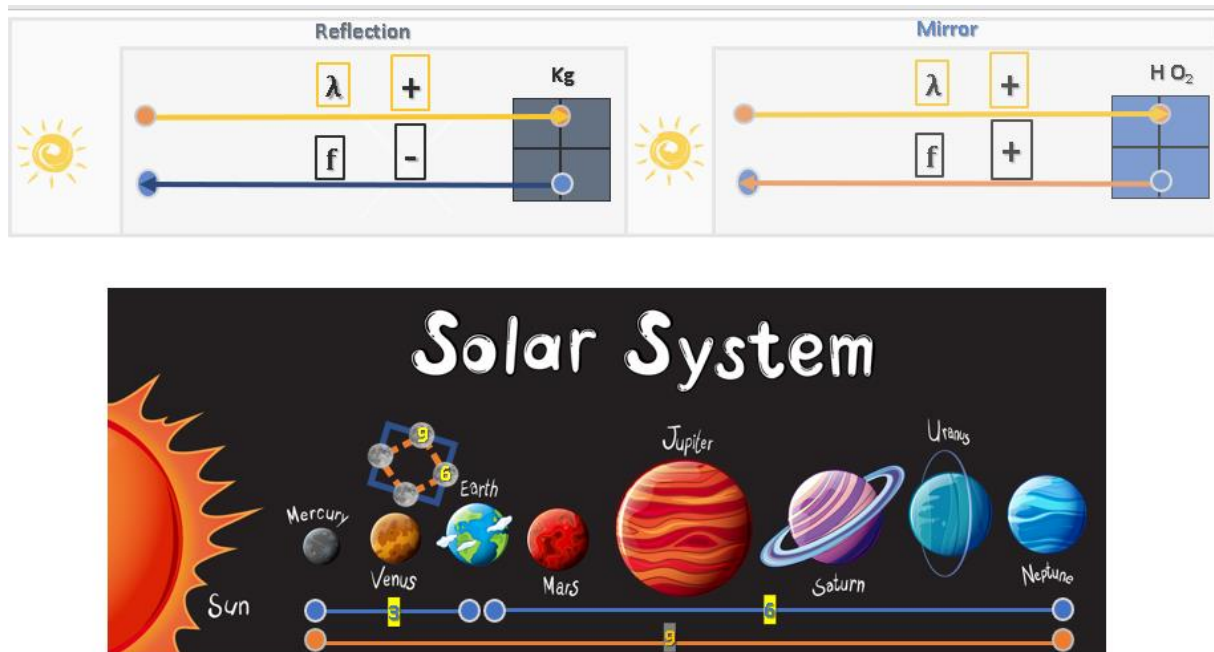

Figure 12: Splitting, polarity reversal of a mass through reflection and mirroring. Source: own illustration

When the human body is viewed as such an object, the magnetic, i.e., the spiritual, level removes itself from the rest. The assumption and imitation of the symbolism, as well as own observations during Covid-19, have led to further investigations of this alpha splitting by infrasound. In order to make this clear, Figure 13 should serve to describe this alpha splitting in more detail using the example of a human body.



Figure 13: Alpha splitting in medieval symbolism. Source: own illustration

The stability in nature can only be restored when the tunnel effect binds Covid-19 particles with their magnetic effect in the cycle, which means that the balance in nature can be maintained. This results in a distinction between linear and quadratic relationships, which are location and time dependent.

This results in the lifespan and energetic impact being in a $1/6$ ratio to balance the stability on earth towards the earth's oscillation every 120 years. It is like an hourglass that keeps turning over time. Figure 14 shows the location and time dependence of such particles. The fragmentation of the image into triangles is based on the fact that particles move at the speed of light, which can only be calculated by drawing lines.

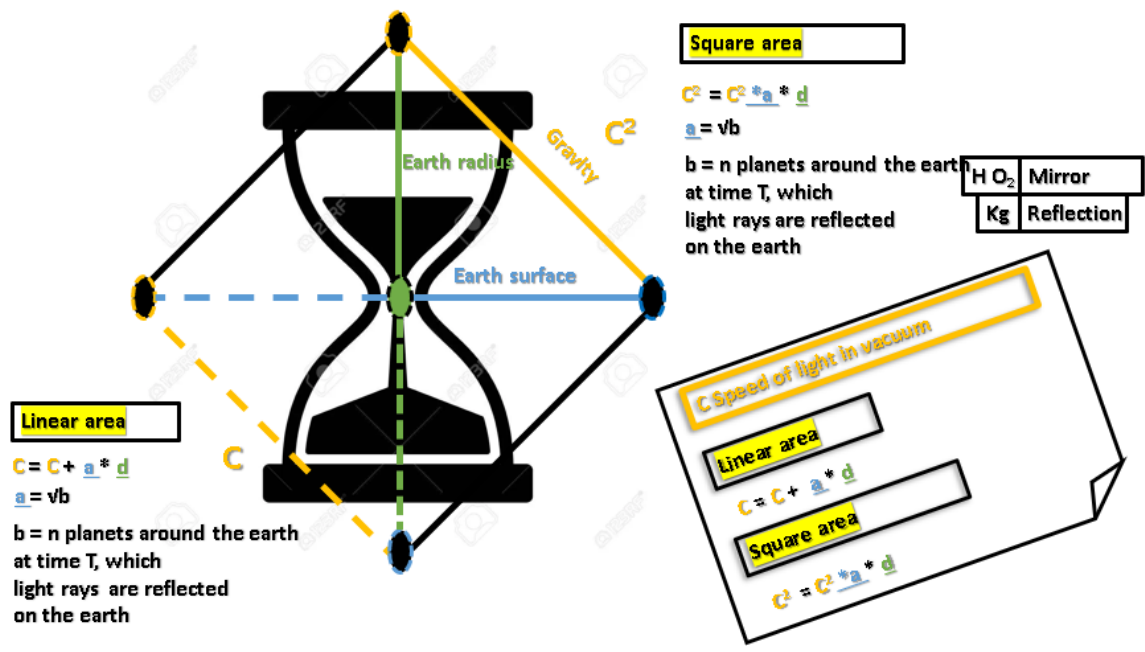

Figure 14: Covid-19 particles time and location dependent. Source: own illustration

In order to refer from the mass to the human body, Figure 15 and Figure 16 should serve to describe the relationships in more detail. It is an interplay between the magnetic spiritual level and Covid-19 particles in their magnetic impact. Hereby, it is important to note that this alpha splitting leads a human to death after six times, or the human can be called clinically dead.

Such a death can only be prevented through faith and an interplay with heaven or through a scientific path that relies on frequency technology as a solution. Within this context, the Covid-19 particles are commutated to their original shape and then destroyed.

Furthermore, the difference between the spatial and time dependence as well as the difference between the linear and quadratic domain must be taken into account, which can be clearly emphasized by missing particles in the linear domain. The location and time dependency relate to the cosmic rays in the infrasonic frequency range, which means that a missing particle can be replaced.

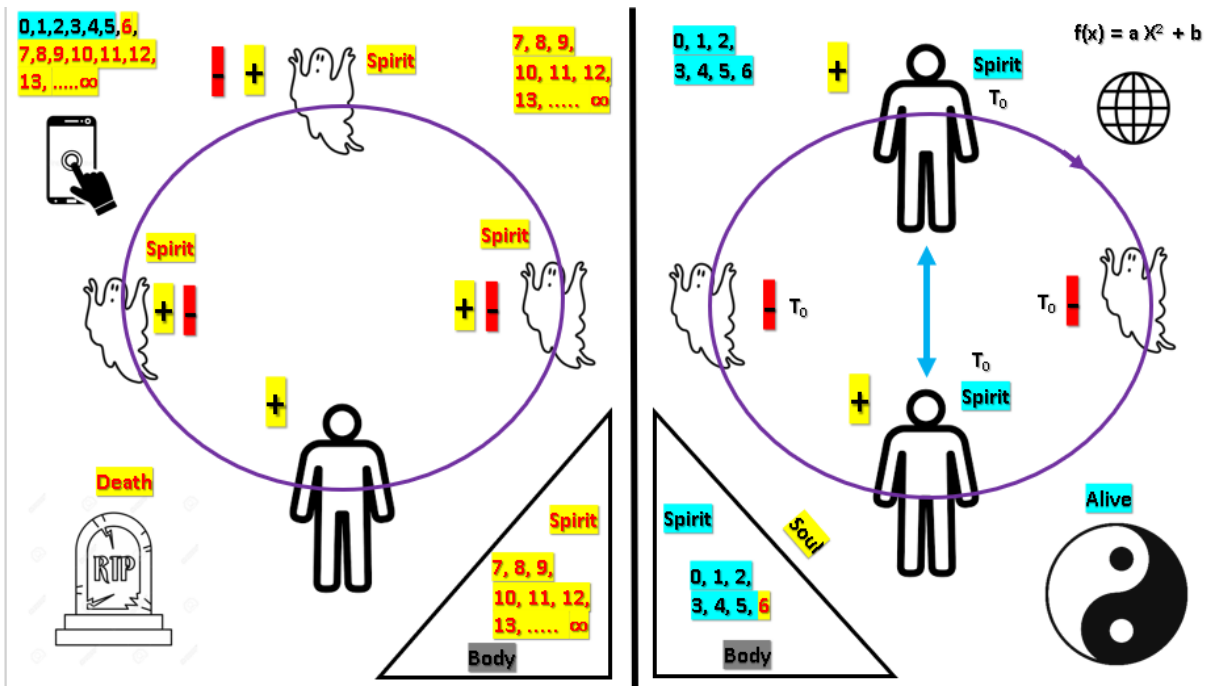

Figure 15: The human body in a square area. Source: own illustration

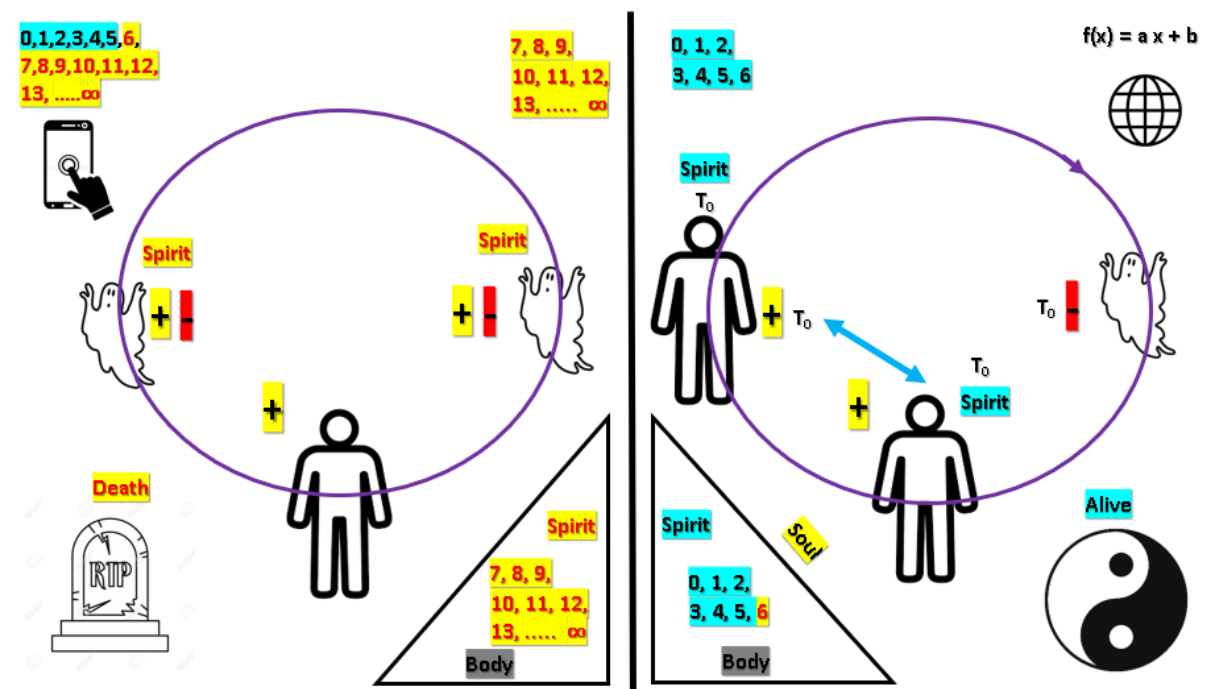

Figure 16: The human body in a linear domain. Source: own illustration

According to my own observations, the phenomenon of alpha splitting is expressed in the form that people suffering from Covid-19 suddenly have different eye colors. However, this is limited in time. In order to be able to describe the temporal reference in the interplay in more detail, Figure 17 should serve as an illustration.

Furthermore, the figure clearly shows that the ratio in a square or in a linear area does not differ in time, since in a square area, there are two Covid-19 particles interacting and playing the role of one play energy carrier in a linear cosmic ray in the infrasonic frequency range.

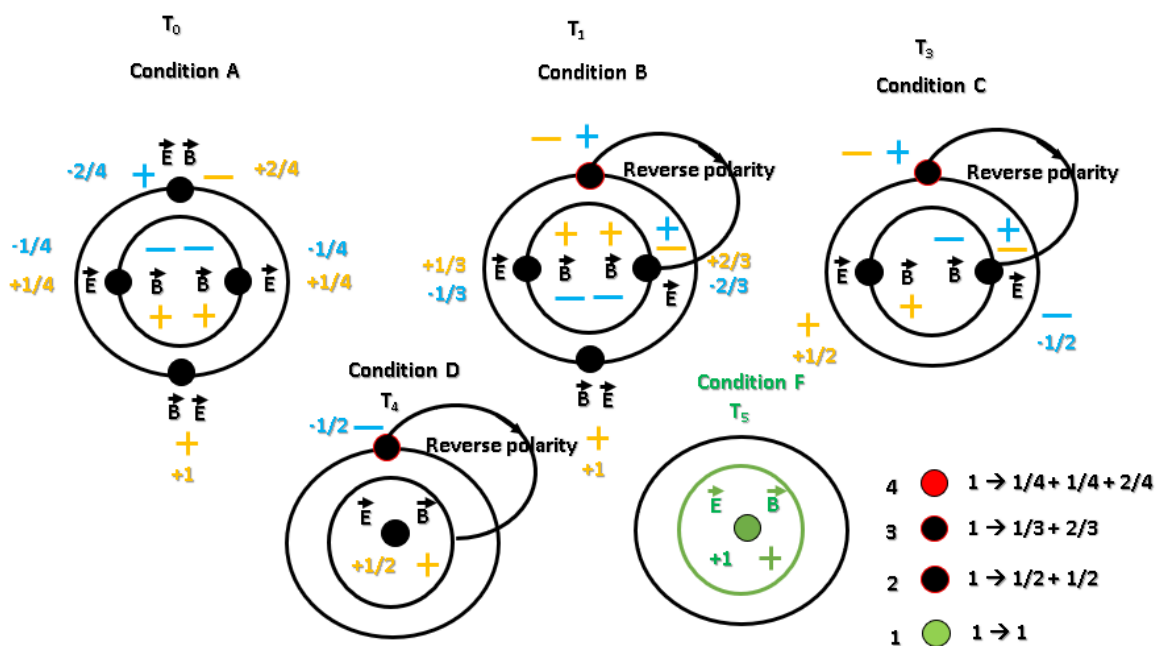

Figure 17: Time course of the Covid-19 particles in interaction with the human body or a mass. Source: own illustration

1.5. CO2-increase during the Covid-19 crisis

The present work conducts the discussions in an exploratory manner, so that the knowledge obtained so far can only be credibly understood when an explanation for the increase in CO2 during the COVID-19 pandemic is given. The total reflection, the mirroring of the rays of light and the shift in sea level during a new moon should be used as in Figure 18, so that an explanation for the increase in CO2 can be found by analogy with the Covid-19 particles and the alpha splitting.

A mass will only be measured with a weight when a frequency with a full-fledged lambda is reflected on the earth's surface, whereby altitude and sea level play a role. To illustrate this with an example, a car on the mountain shall be considered next to the new moon. Here, the weight of the car is different in the valley than on the mountain top.

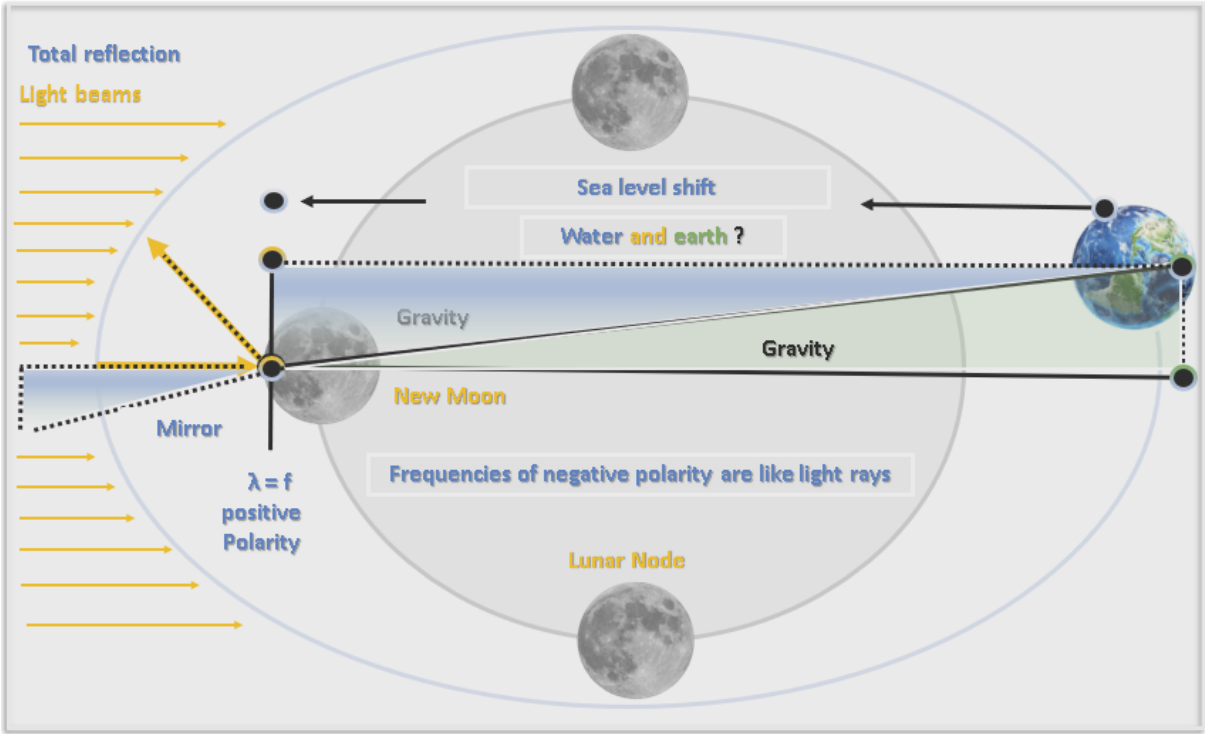

Figure 18: CO2 measurement at new moon as a benchmark for the explanations. Source: own illustration

The reflections of the light rays are the cause of the gravitation and lead to the attraction and repulsion between masses. The impact of the light beams on the water surface enables a polarity reversal of the positively polarized magnetic part of a light beam, which can also be referred to as spin. Furthermore, the negatively polarized reflected and mirrored light beam spreads to the boundary of the geosphere and meets positively polarized light beams, which provide the angular momentum for the rotation of the earth around itself and around the sun.

This increases the proportion of CO₂ and at the same time affects the photosynthesis and sea level shift, especially when, on the one hand, the approach of the earth to the sun occurs every 120 years and, on the other hand, the presence of reflection and mirroring of light radiation is the cause of gravitation. To confirm this, a new moon CO₂ measurement will be taken to serve as a benchmark for its rise during the COVID-19 pandemic. The use of the communication technology of frequencies in the subsonic frequency range affects photosynthesis and causes a shift of oxygen towards the sky within the geosphere, which leads to the fact that, on the one hand, more CO₂ is measured in concentration near sea level and, on the other hand, that the concentration of oxygen is much greater far from the sea level.

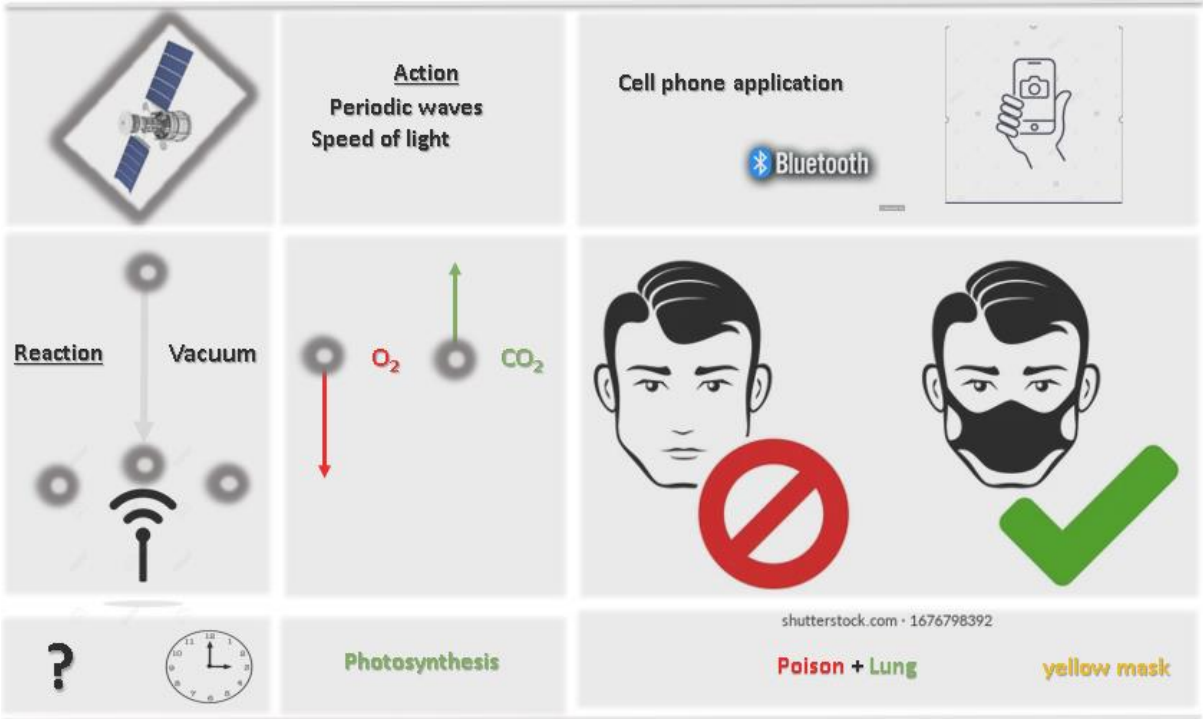

Figure 19: Displacement of oxygen far away from sea level. Source: own illustration

In addition, another characteristic of the infrasonic frequency range and above all of periodic frequencies in the number must not be ignored. It concerns the propagation speeds of such frequencies, which propagate at the speed of light. This causes vacuum since the speed of light is measured in vacuum and Newton's laws exploratively confirm this fact. This is where Newton's third law plays a crucial role.

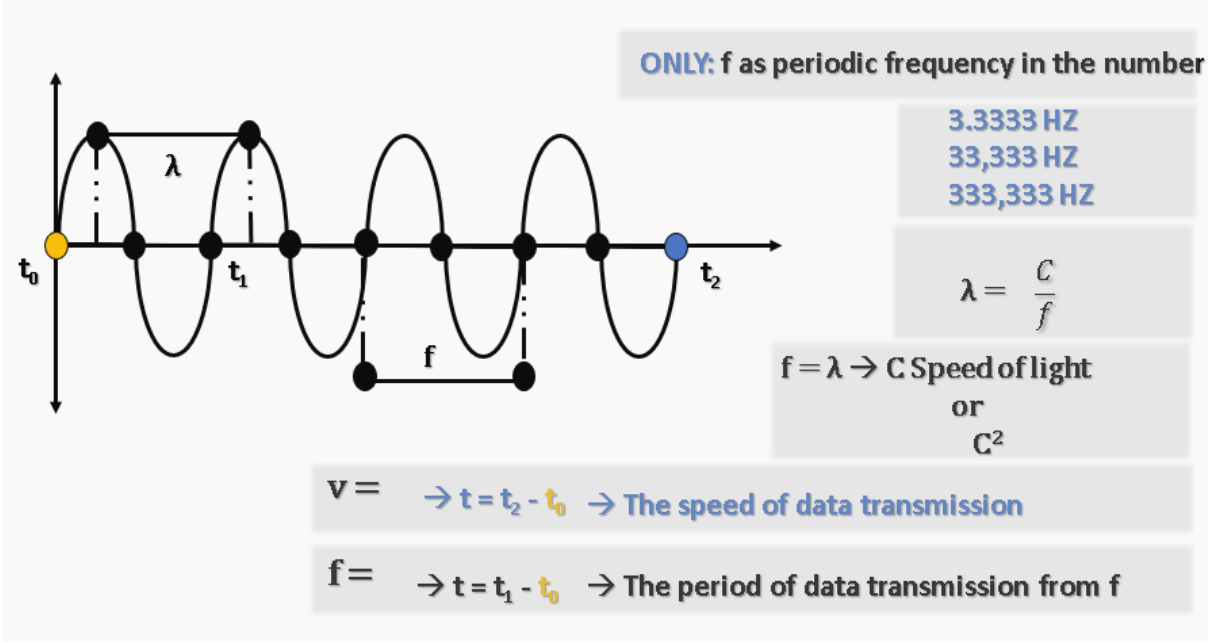

Figure 20: When frequencies in the infrasonic frequency range or periodic frequencies propagate through the air, they cause a vacuum. Source: own illustration

5. Summary and conclusion

The present article has pursued a descriptive and explorative approach, which is based on messages as well as signs and symbolism. In order to increase the credibility of the work and so that common sense is stimulated to think, this work relies on symbolism in the pictures and messages, which are structured according to the motto that a picture says more than 1000 words. They are intended to have a simple and understandable effect on the reader in order to get one step closer to the truth.

6. Conclusion

1.6. Credibility of the work

The credibility of the work consists of simple means such as the use of the Cartesian coordinate system instead of the polar or spherical coordinates. Figure 21 symbolically shows the difference between the coordinate systems. The idea behind it was simple, as the author of the present work put himself in the shoes of the discoverers and inventors of this scientific knowledge 120 years ago.

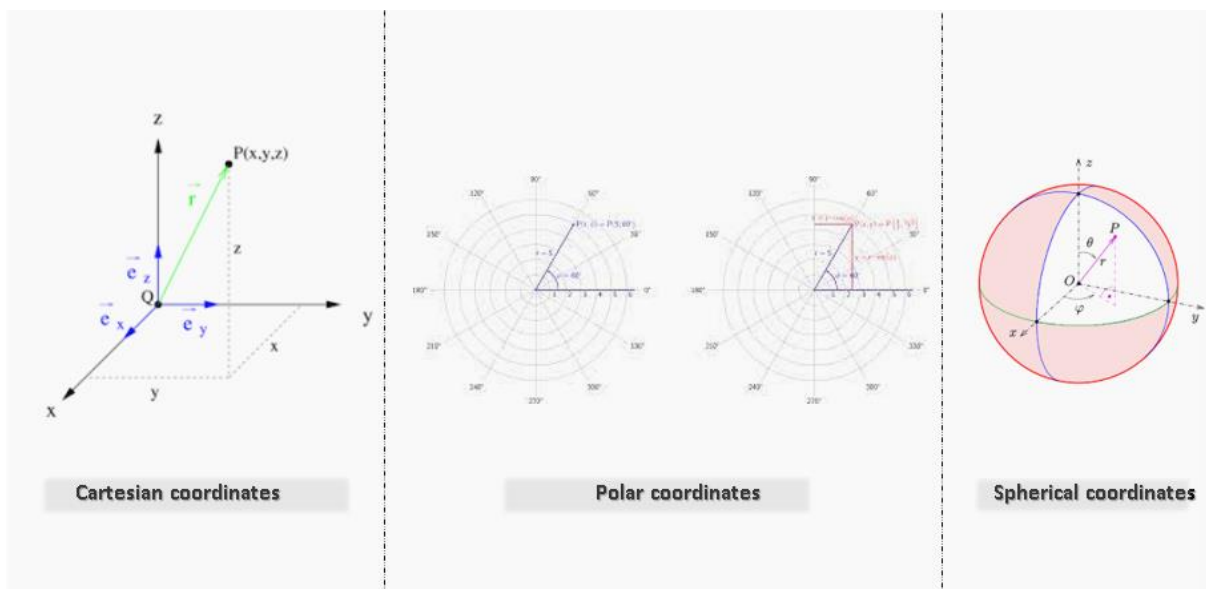

Figure 21: Coordinate system. Source: own illustration

Another strength of the present work is the use of symbolism and symbolic mathematics, which could make some unpredictable formulas calculable. As an example, consider Figure 22 and Figure 23, which depict the Pythagorean triangle as a series, and how and when symbolic

mathematics can be useful in this triangle when it is physically relevant. Only on the basis of this consideration was it possible to simulate the geometry in Figure 23.

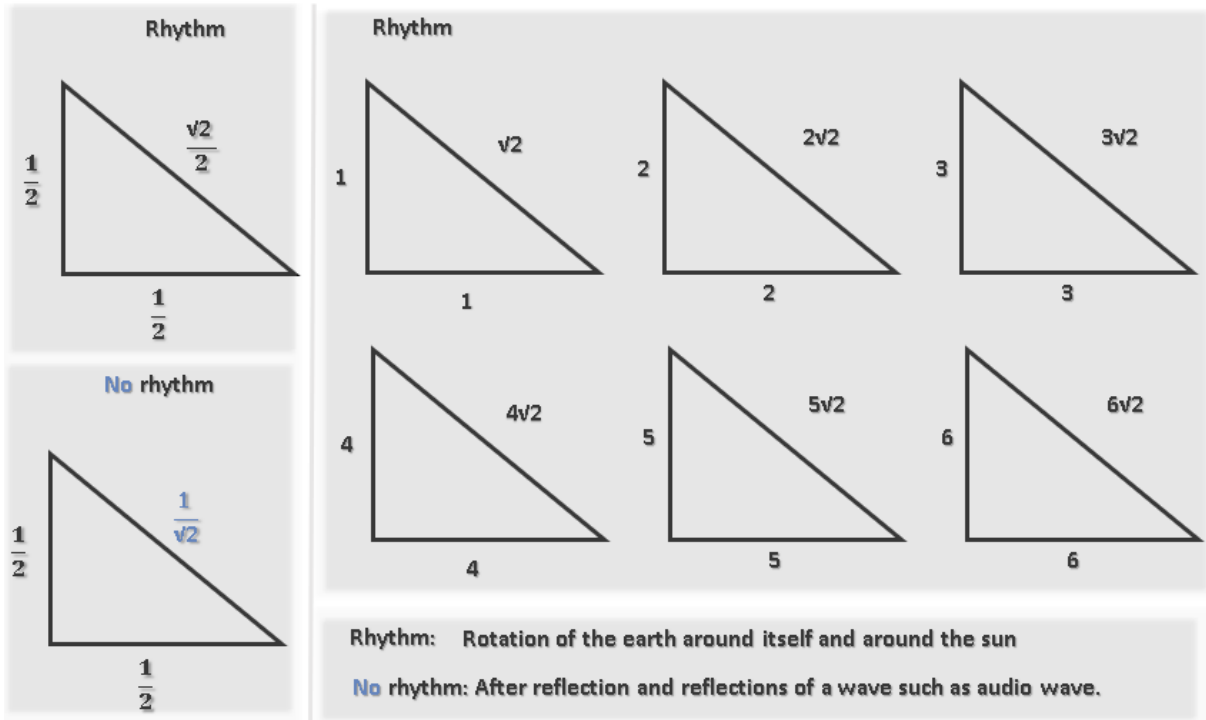

Figure 22: Pythagoras as a series both in a rhythm and without a rhythm. Source: own illustration

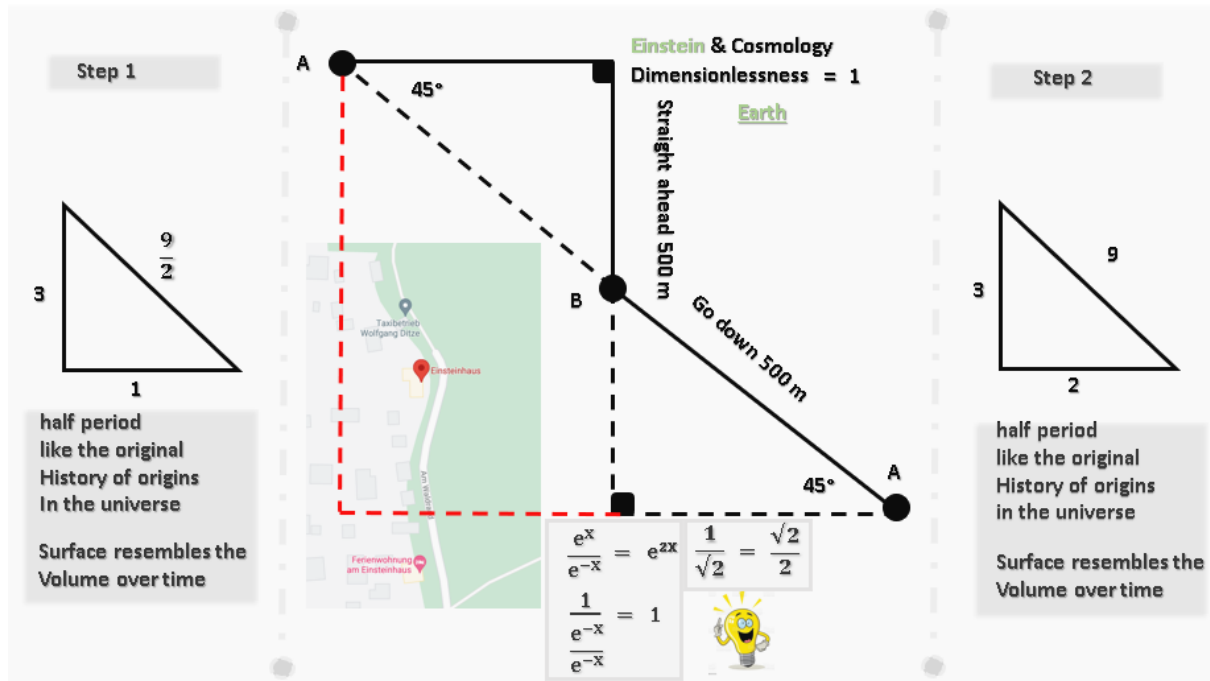

Figure 23: Einstein's summer house as a basis for simulating the solutions of Covid-19 particles. Source: own illustration

6.2. Intended uses of the Covid-19 particles and solutions

The conclusion should serve to clearly emphasize the difference between what normality means from your own point of view and life with Covid-19 particles. Figure 24 shows normality in life and life with Covid-19 particles.

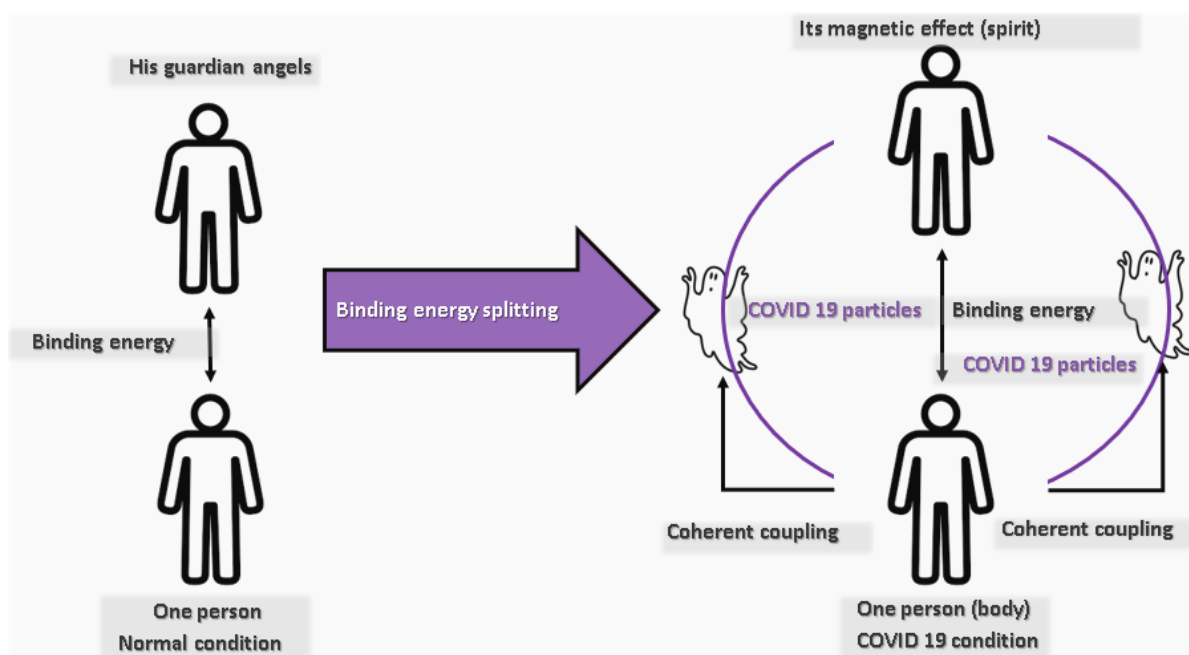

Figure 24: Normal life and life with Covid-19 particles. Source: own illustration

One application of this split is the heteronomy of people by separating the magnetic part of the human body, i.e., the spirit, from the rest. This creates tunnel effects at a ratio of 1:4, with Covid-19 particles slipping in between, i.e., tunneling the cycle. A remote control of such particles allows the heteronomy of people for various purposes. Figure 25 clarifies the situation. Another application is shown in Figure 26, which describes in more detail that such particles are able to make themselves visible and invisible or to transform themselves through their magnetic energy.

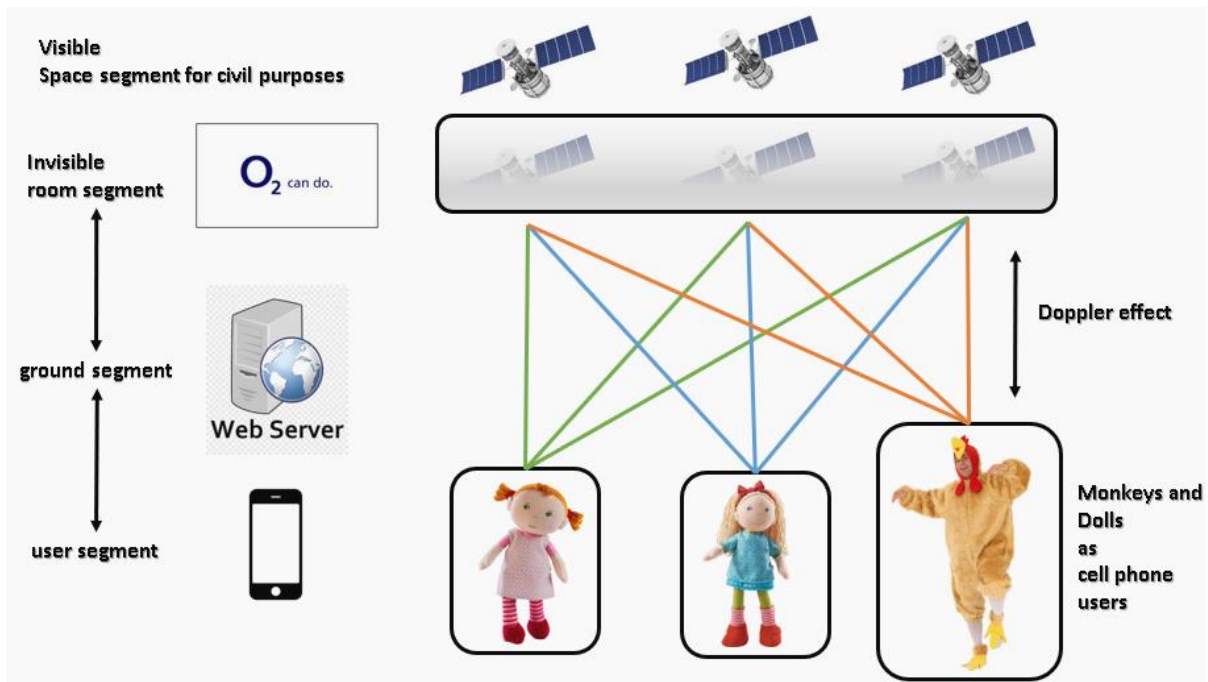

Figure 25: Heteronomy through the tunnel effect. Source: own illustration

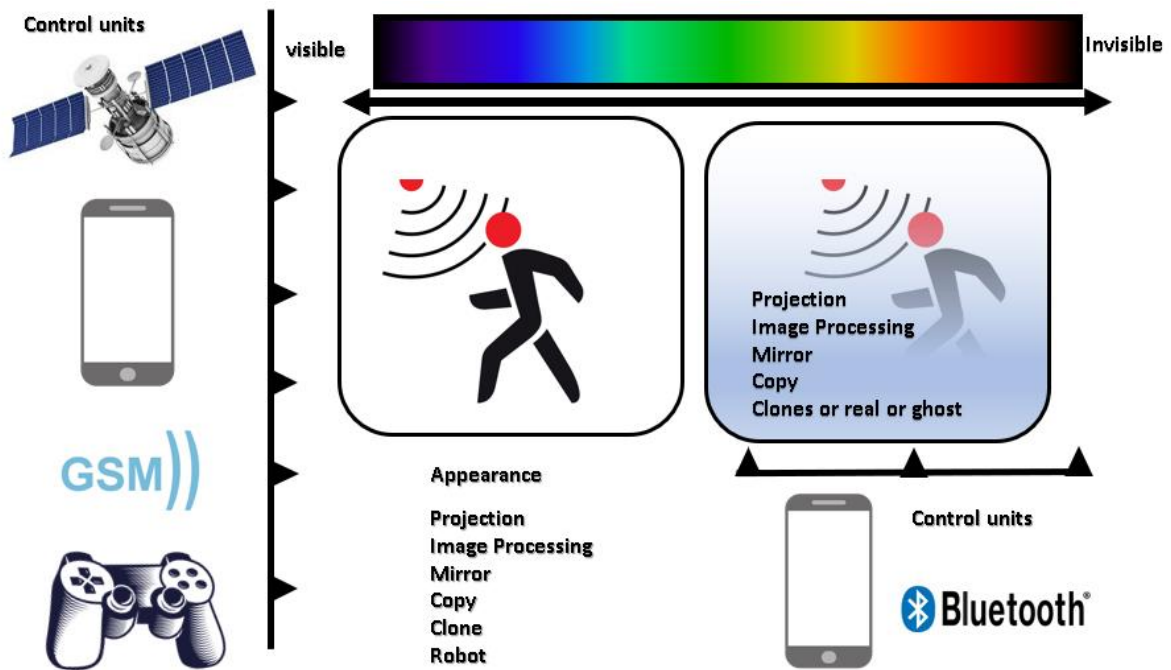

Figure 26: Capabilities of Covid-particles. Source: own illustration

As discussed in the first volume of this series about solutions using frequency technology, this essay continues to follow this approach by requiring a forward-looking and wait-and-see attitude, so that the solution can only be described in more detail in two steps. This shows the approach by breaking the coherent coupling of the Covid-19 particles in one step and then reversing the polarity in a second step. This ensures that such particles are converted back to their origin - according to the motto: "Ashes to ashes and dust to dust".

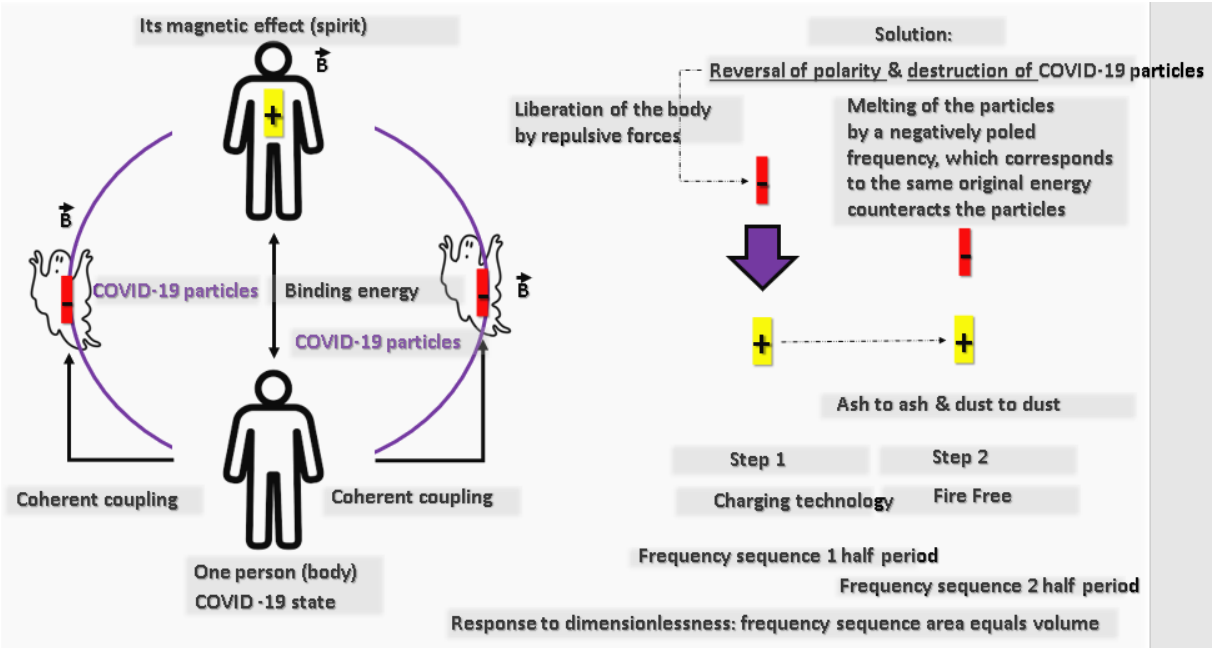
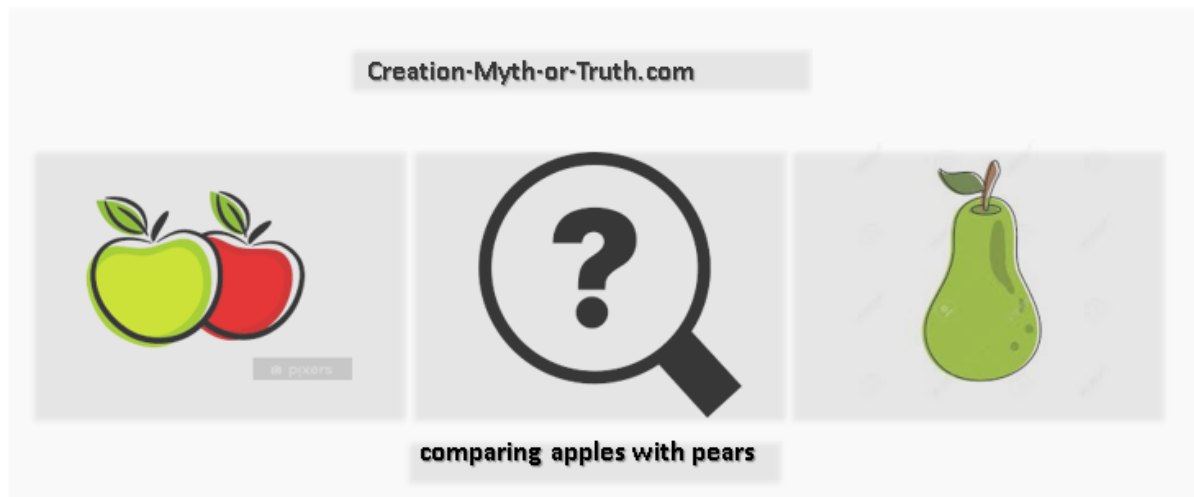

Figure 27: Solutions for Covid-19 particles and the new charging technology according to Bismarck. Source: own illustration

Teil II: The creation-between-Myth-and-Truth.com



1. Where is the problem?

When it comes to creation in this article, then the interplay between cosmic rays and living beings on earth should be considered. Here it is necessary to draw attention to the fact that some living people on earth do not rely on pregnancy, but advance their reproduction through a physical interplay (light and/or frequency waves) argumentatively in the name of Christian creation.

In non-Christian countries, such an interplay is referred to other reasons. As an example, the religious division between Sunnis and Shiites in Islam could be an argument not to bet on pregnancy. Another argument for not counting on pregnancy is that cross-generational ethnic groups, such as Kurds and Yazidis, argue that such an interplay is a tradition.

2. Questions and target

The spiritual development since creation and time zero is a function of time, which is there to better understand the evolutionary development of mankind. Through linguistic development one was able to communicate. The history and historical data provide enough material to create something spiritually that others can understand. The question is therefore: When did the reckoning of time begin? When did people write something and transmit it to others?

How much trust should one place in historical data? When did the first man live on earth and how many were there? How was the earth formed? How many years did it take for the solar system to function and remain stable in the form we know according to the current zeitgeist? Above all, what is still missing to learn more about the universe? Some of these questions raised have been answered in the first part of this essay, especially regarding Covid-19 particles and their magnetic energy.

But what about the remaining questions? Can a human brain understand all of this? Where is the credibility in science? What shall we believe? Is it all just to deny Corona or to position oneself against vaccination? All these questions should be considered in the course of the present work from the point of view of the problem that pregnancy is not focused, but rather the interplay since Adam and Eve, on which the traditions are based.

This is a conversion of a living being into a human form, which is made possible by the very high magnetic energy of two waves in the infrasonic frequency range. Such an energy with two equal frequencies in the infrasonic frequency range with a value as the reciprocal of the speed of light can also create or revive living beings. In order to be able to describe the problem and the objective, Figure 28 should serve to raise the question: Where do the ants come from in the concrete soil and the flies in rotten fruit and vegetables?

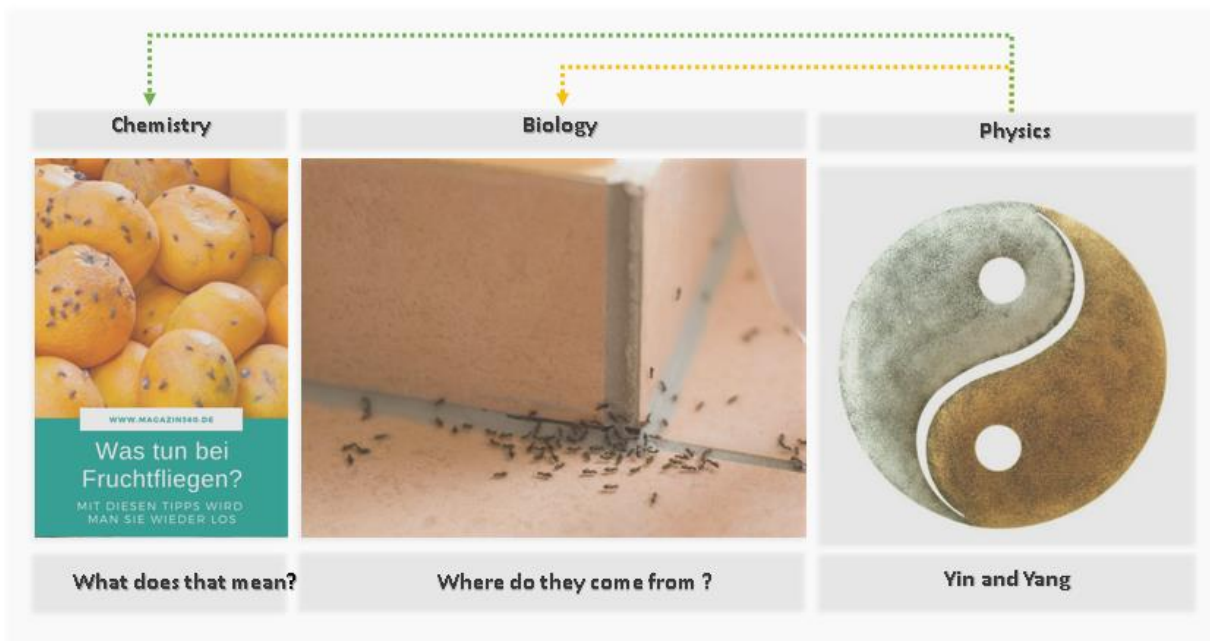

Figure 28: Creation related to energy and an interplay between frequency and chemistry. Source: own illustration

3. Motivation of the essay

The motivation of the present paper is to integrate the traditions from the Old and New Testament into the science of physics and astrophysics. Analogical conclusions are intended to strengthen the credibility of the discourse. Belief in something requires standards and comparisons to what is known, using the story from Germania as shown in Figure 29 to suggest that the Teutons at that time had peacefully embraced the Christian religion, as they had something similar to the Lord's Prayer from the Bible in their narratives.

The story is about two frogs, one is the father and the other is the son. Both have fallen into a glass with milk. The father does not make it out and drowns. The son keeps fighting until the milk turns into butter. Eventually he manages to jump out of the glass.



Figure 29: Lord's Prayer from Germania. Source: own illustration

Another motivating factor is the author's vision of the life of Jesus up until he was crucified and resurrected. This is the truth of Covid-19 particles. When speaking of Covid-19 as particles, they are soft ferromagnetics in their physical nature. The formation of planets and stars over millions of years began precisely through accumulations of such particles, which stabilized over time in the form of the current solar system.

Such particles have existed for as long as the earth and the people on the earth. They have magnetic energy and millions of degrees of freedom, enabling them to assume any form, even human. They can live with us as human beings, but in truth they are not human. They can live with us as animals, but in truth they are not animals. They do not rely on pregnancy for their reproduction, but on a physical interplay and a magnetic energy behind it.

These facts remained invisible until Jesus was crucified and until he revealed them, according to the assumption and the thesis of the present essay. Figure 30 illustrates the vision and assumption of the thesis. They rely on physical phenomena such as the tunnel effect to control people from the outside. At the same time, due to their magnetic effect in the infrasound frequency range, they have so much energy that every wish can come true, depending on the time and place.

It is thus reasonable to assume that science has long known about such Covid-19 particles, but has lost control of what triggered a pandemic. The skills of heteronomy could be used in the name of security engineering, so that many have jumped on that horse. The theses addressed are motivating factors, primarily because they are not biological in nature, but rather something that humanity has been living with for ages.

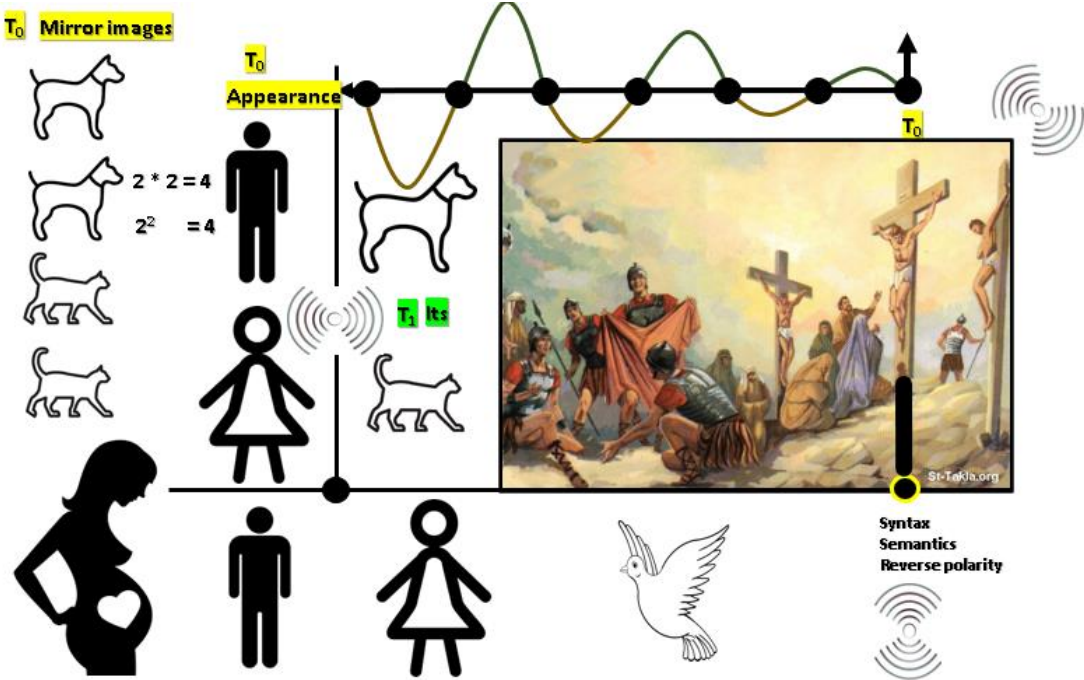

Figure 30: Jesus on the cross and Covid-19 soft ferromagnetics. Source: own representation

Another vision about Jesus throughout his life is his superpowers and energetic miracles of revealing such particles and their dimensions since he was a carpenter.



Figure 31: Jesus as a carpenter and the ability to show Covid-19 particles in their dimensions. Source: own illustration

4. What is Christian creation to not to rely on pregnancy?

It is important to note again at this point that the assumption and the thesis of the present work refer to the fact that a transformation takes place on the basis of a physical interplay. This is used to ensure that living beings do not rely on pregnancy. Two waves are required, which contain the reciprocal value of the speed of light as a frequency.

Fehler! Verweisquelle konnte nicht gefunden werden.

A transformation of a physical nature can thereby be made possible. In the presence of light, creation begins at the age of two. But if only frequency waves play a role in the interplay, then creation begins from one year. Figure 32 illustrates the interplay.

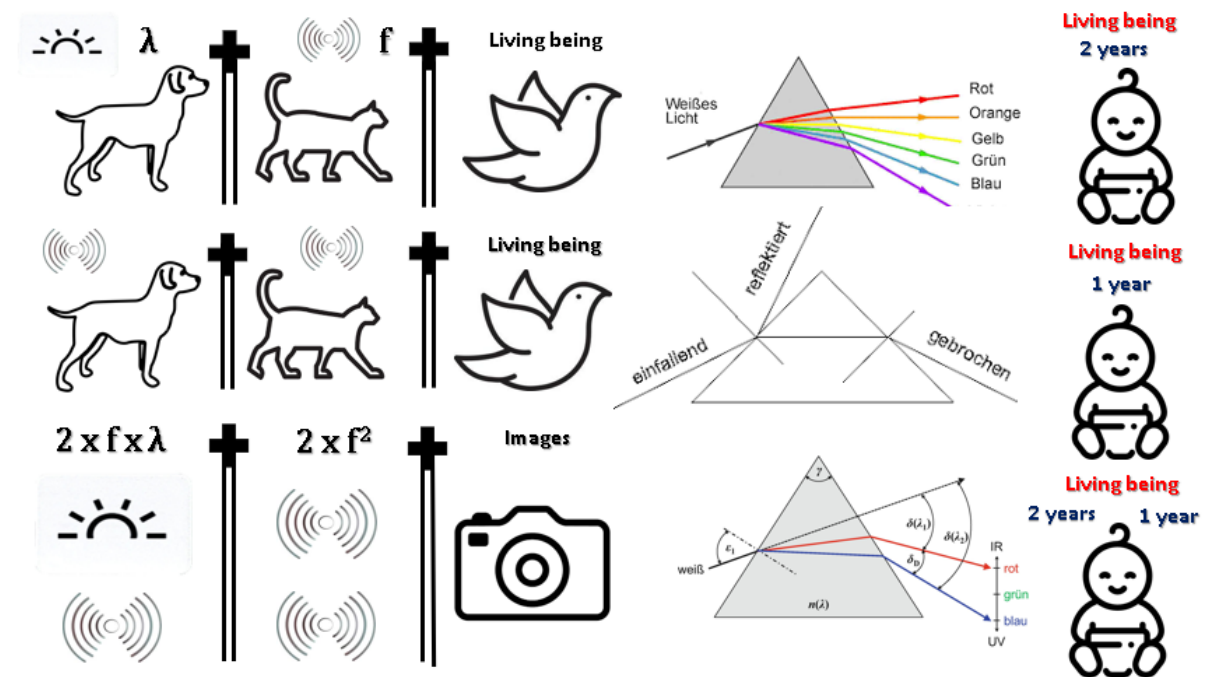

Figure 32: Creation and transformation of living beings. Source: own illustration

These creations according to this pattern are given the same abilities that Covid-19 particles possess, since they have the same origin. They can transform and have the ability to grant any wish as they can make themselves invisible to the human eye. It applies to them that they only become full human beings after 21 years - provided the original state was a living being.

Another ability of magnetic energy possessed by infrasonic frequencies is the ability to revive a living being. It should be noted that such energies can also heal a terminally ill person by removing the magnetic spiritual parts from the rest and allowing a tunnel effect for Covid-19 particles. Figure 33 and Figure 34 show such capabilities.

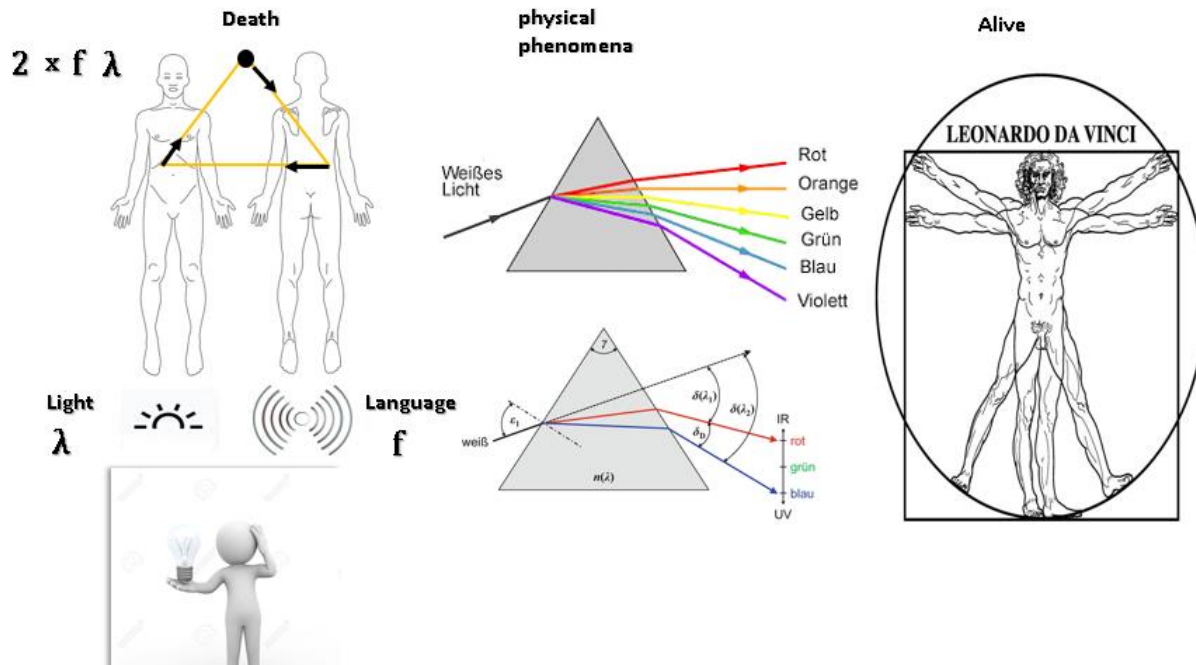

Figure 33: Resuscitation skills with a frequency and a light wave. Source: own illustration

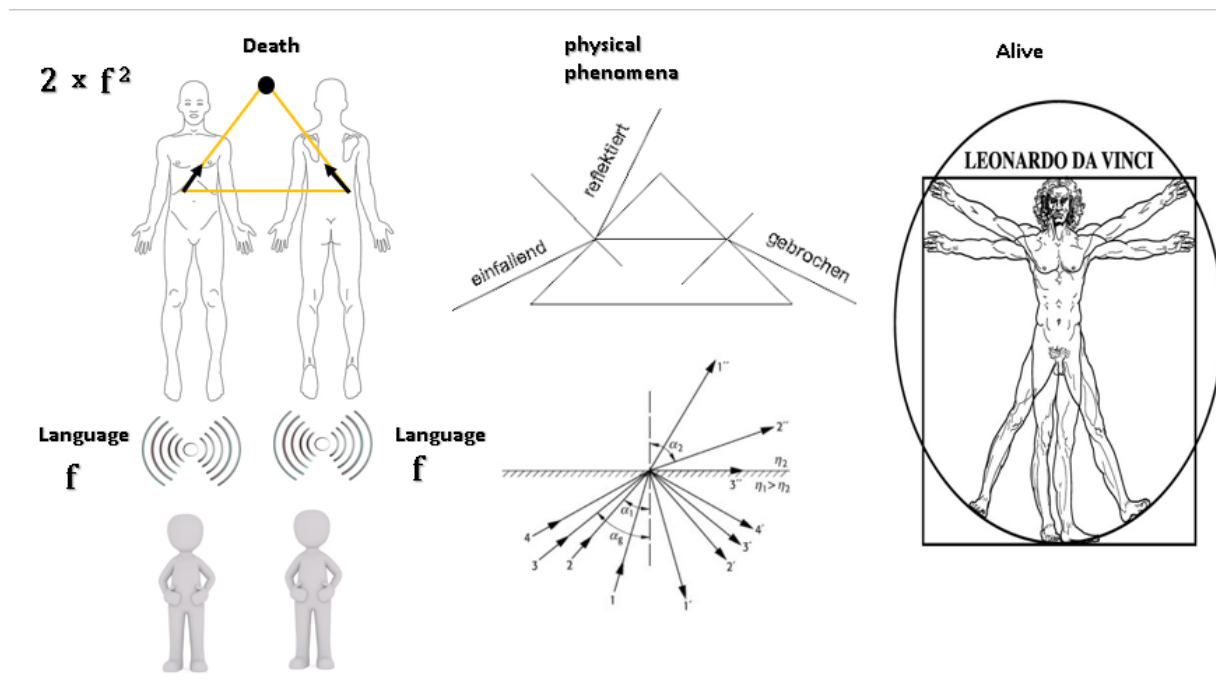

Figure 34: Resuscitation skills using two frequency waves. Source: own illustration

5. Exemplary purposes of creation

The first intended purpose of the insights of creation is the use of magnetic energy in case of a wave. It does not matter whether the wave is of a frequency nature or a light wave. Solely the lambda in the infrasonic frequency range determines the amount of energy. This statement can be confirmed if one considers that it would otherwise not be possible for a light wave to travel from the sun to the earth in just 8 minutes – and has done so for thousands, if not millions of years.

This energy can not only cause alpha splitting and a removal of the magnetic, i.e., spiritual, parts of a human body from the rest, but also enable the tunnel effect in the aftermath, so that there is the possibility of controlling people from the outside.

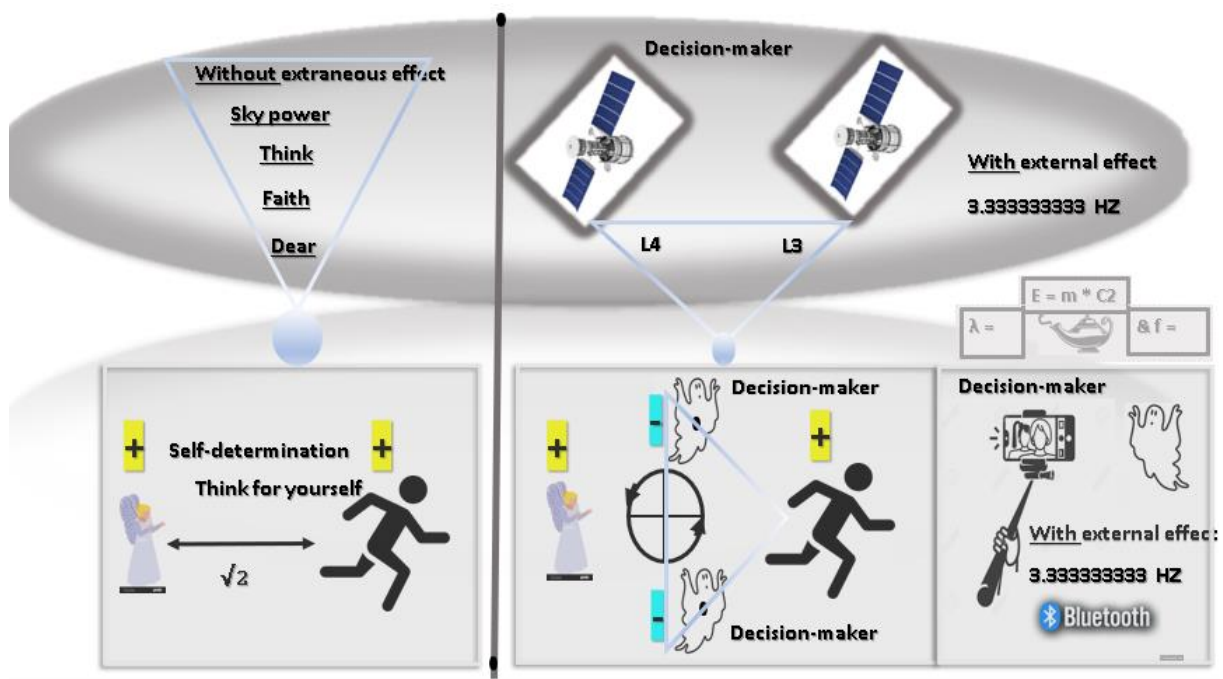

Figure 35: Heteronomy according to the current zeitgeist. Source: own illustration

Further purposes of the insights of creation are illustrated with images, which the following figures are trying to show. Here, the motto: "A picture says more than 1000 words" can be clearly seen, which makes the extent of the catastrophe or rather the pandemic clearer in order to draw conclusions about the real reason for various phenomena during the Covid 19 pandemic.

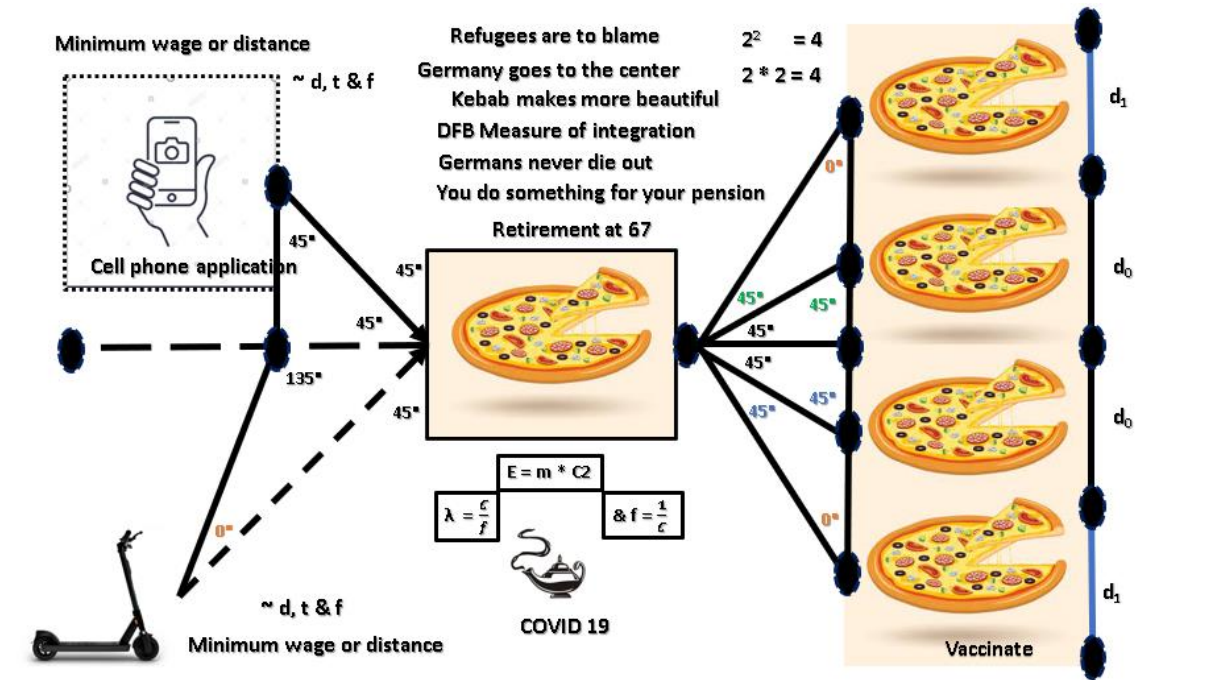

Figure 36: Purpose of the Christian creation in food according to the current zeitgeist. Source: own illustration

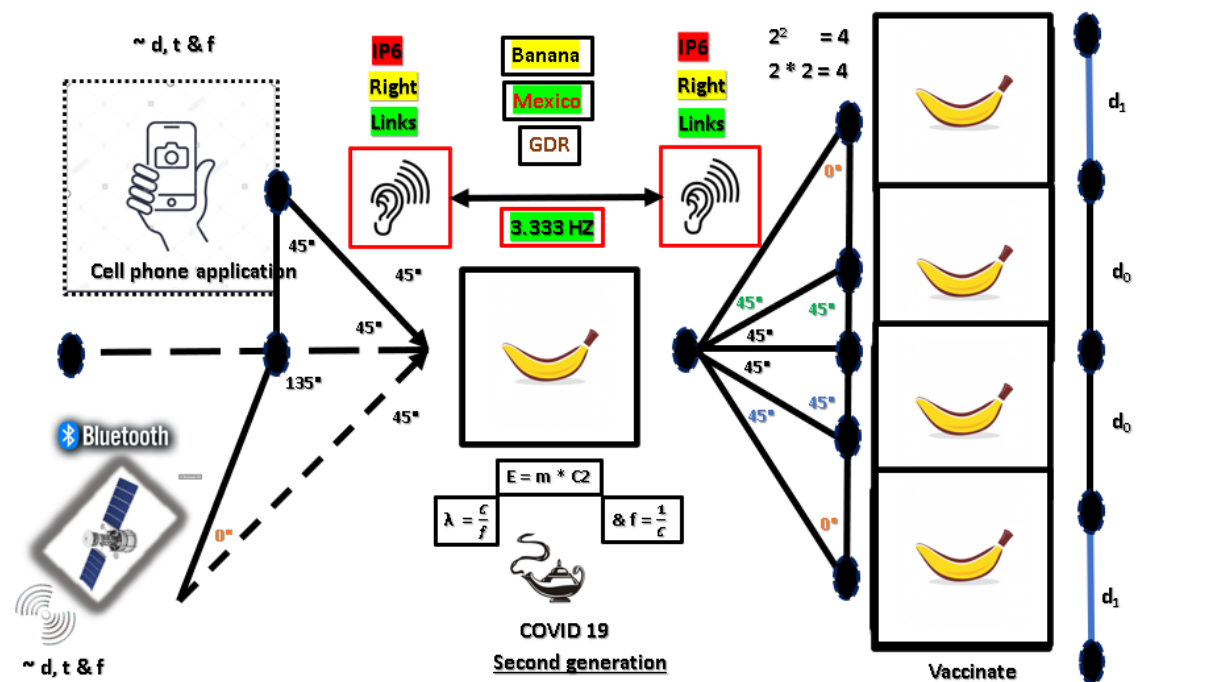

Figure 37: Intended purpose of the Christian creation in food according to the current zeitgeist. Source: own illustration

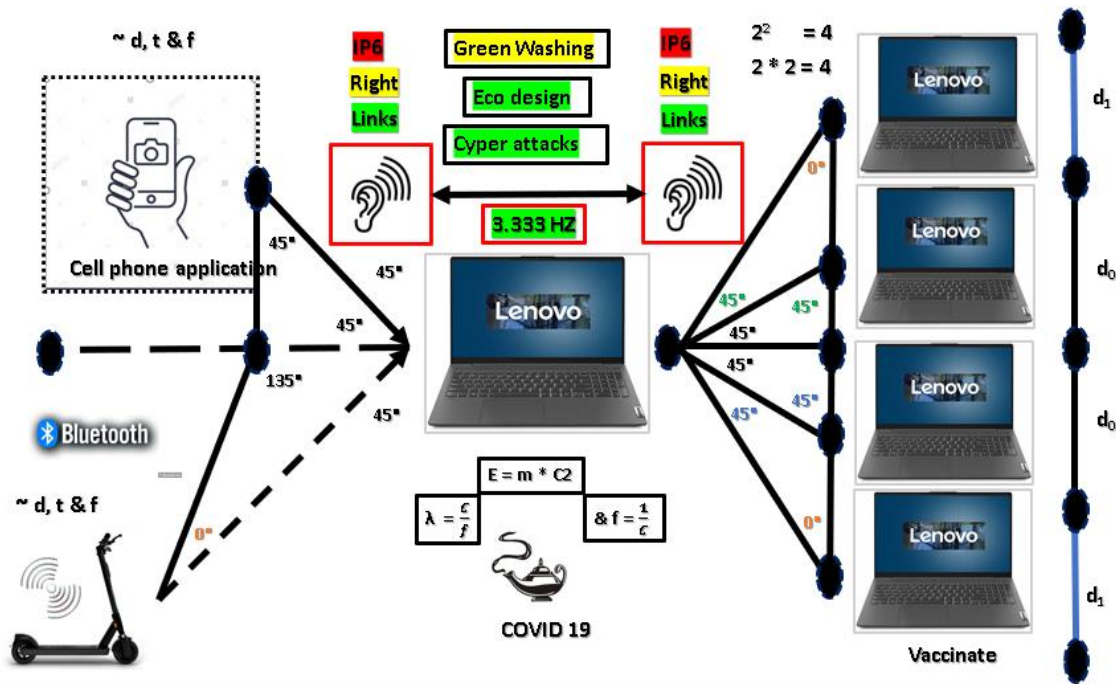

Figure 38: Intended purpose of Christian creation in earth resources according to the current zeitgeist.

Source: own illustration

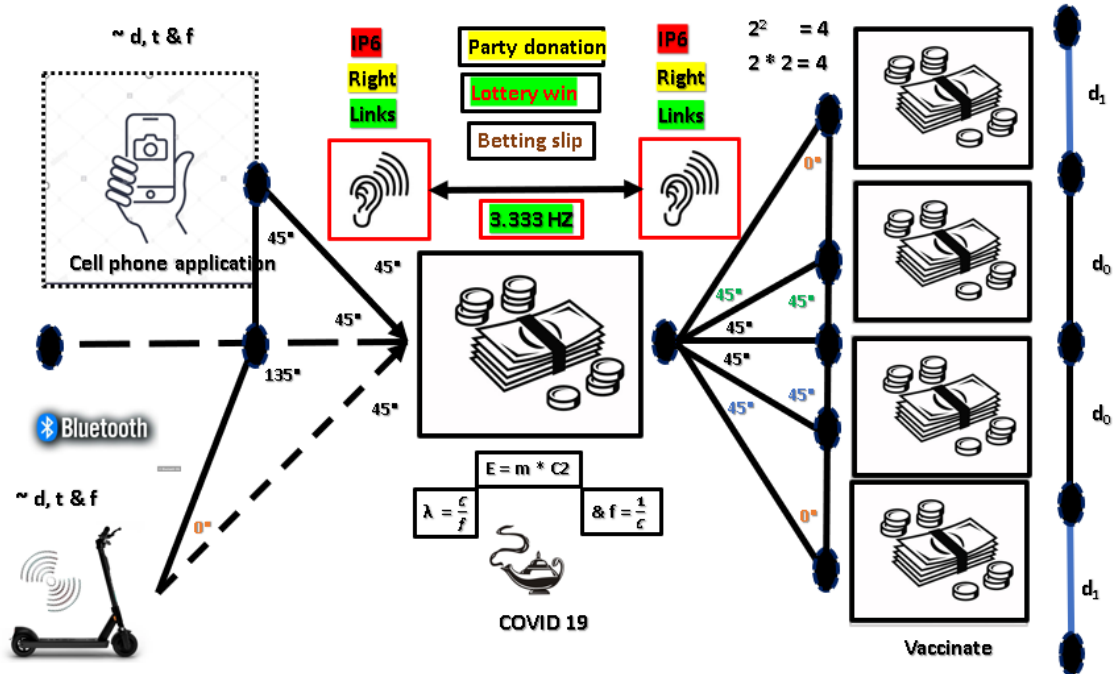

Figure 39: Intended purpose of the Christian creation in a currency according to the current zeitgeist. Source:

own illustration

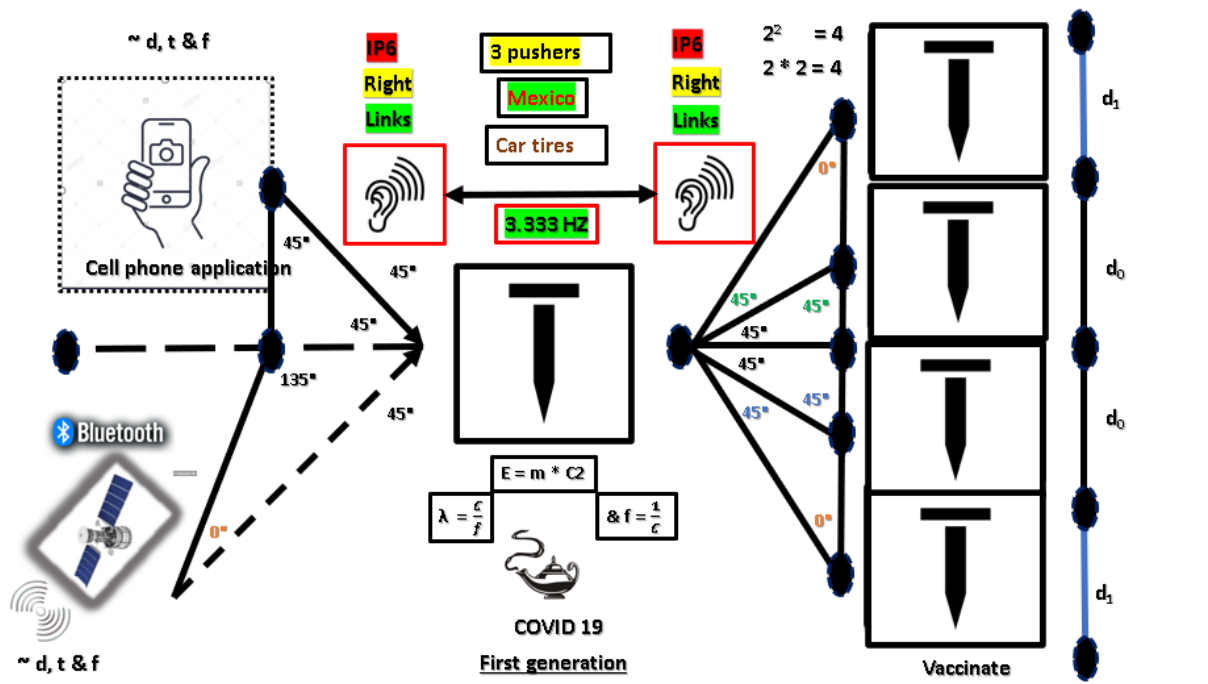

Figure 40: Application of the Christian creation in the building material according to the current zeitgeist.

Source: own illustration

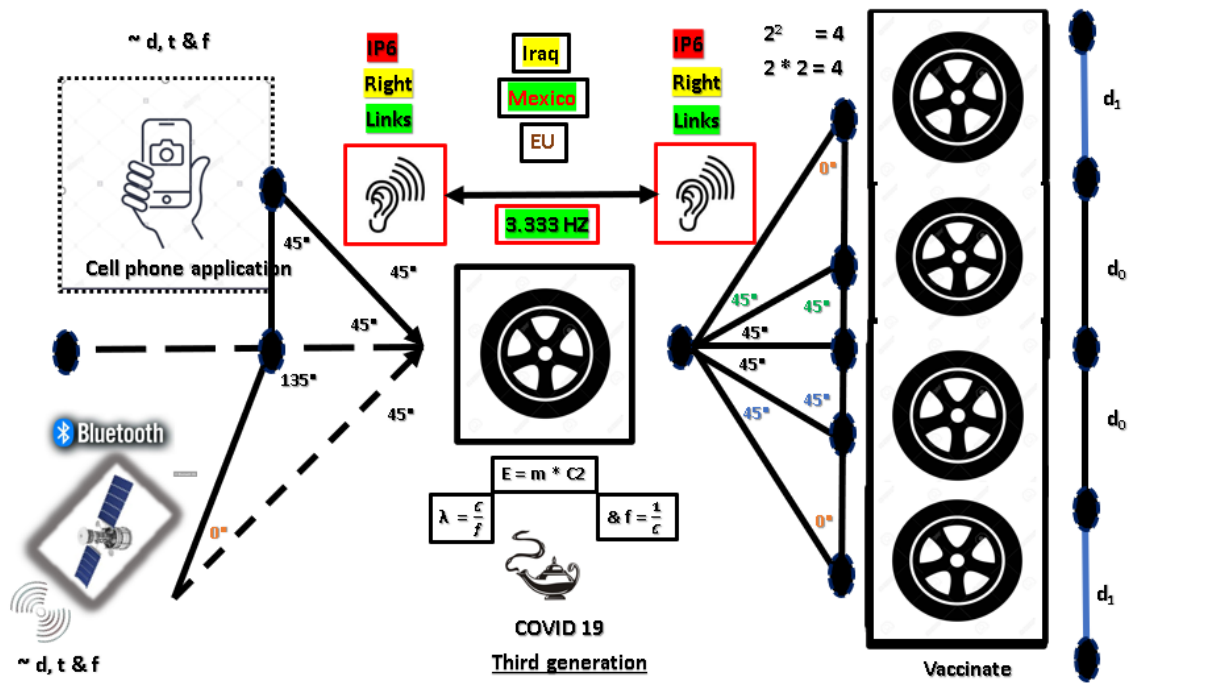

Figure 41: Intended purpose of the Christian creation in the metal industry according to the current zeitgeist.

Source: own illustration

6. Summary and conclusion

The present article has pursued a descriptive and explorative approach, which is based on messages as well as signs and symbolism. In order to be able to increase the credibility of the work and so that common sense can be stimulated to think, this work relies on symbolism in the pictures and messages, which are structured according to the motto that a picture says more than 1000 words. This way, they influence the reader in a simple and understandable way to get one step closer to the truth.

7. Conclusion

In order to increase the credibility of the work, attention should be drawn to the comments made by the Pope from Rome during the Covid-19 crisis and especially during the first lockdown. In doing so, he repeatedly emphasized that Dante's hell and Dante's paradise are important topics during the Covid pandemic.

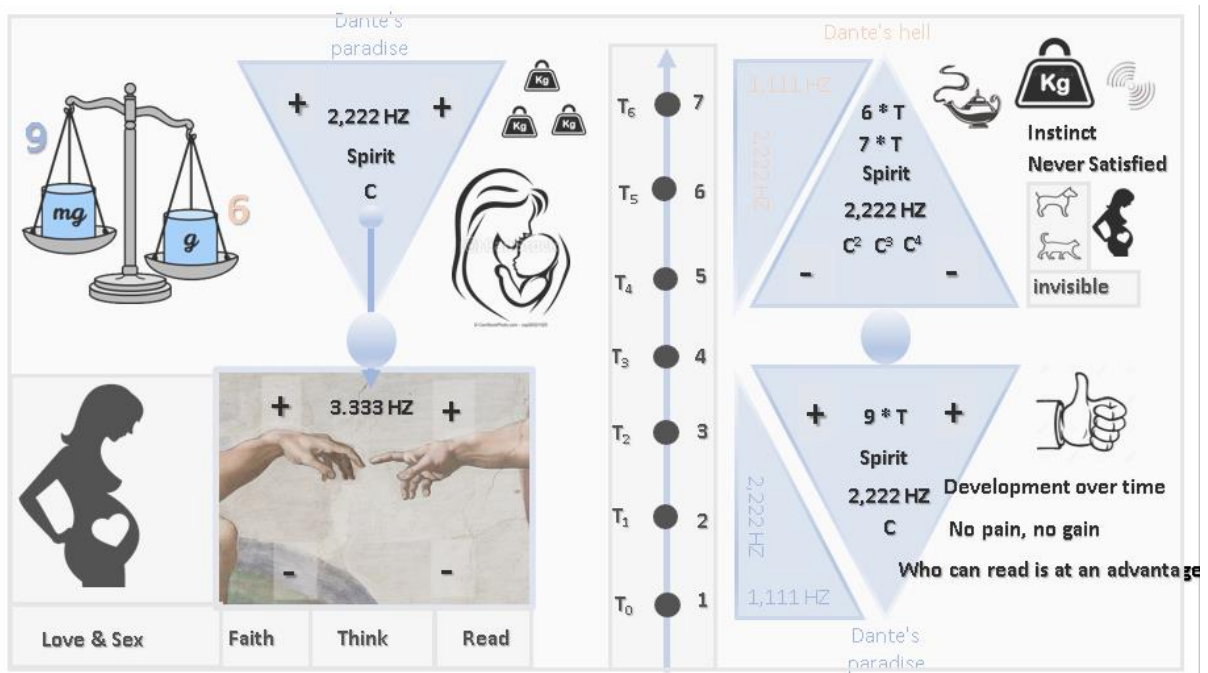

Figure 42: Dante's Hell and Dante's Paradise. Source: own illustration

Finally, it should be noted that Covid-19 particles have existed since creation, i.e., since Adam and Eve. They have skills and a memory. Moreover, they are also able to splinter something in a so-called alpha-splitting process, which can separate the spirit, i.e., the magnetic parts of a human body, from the rest.

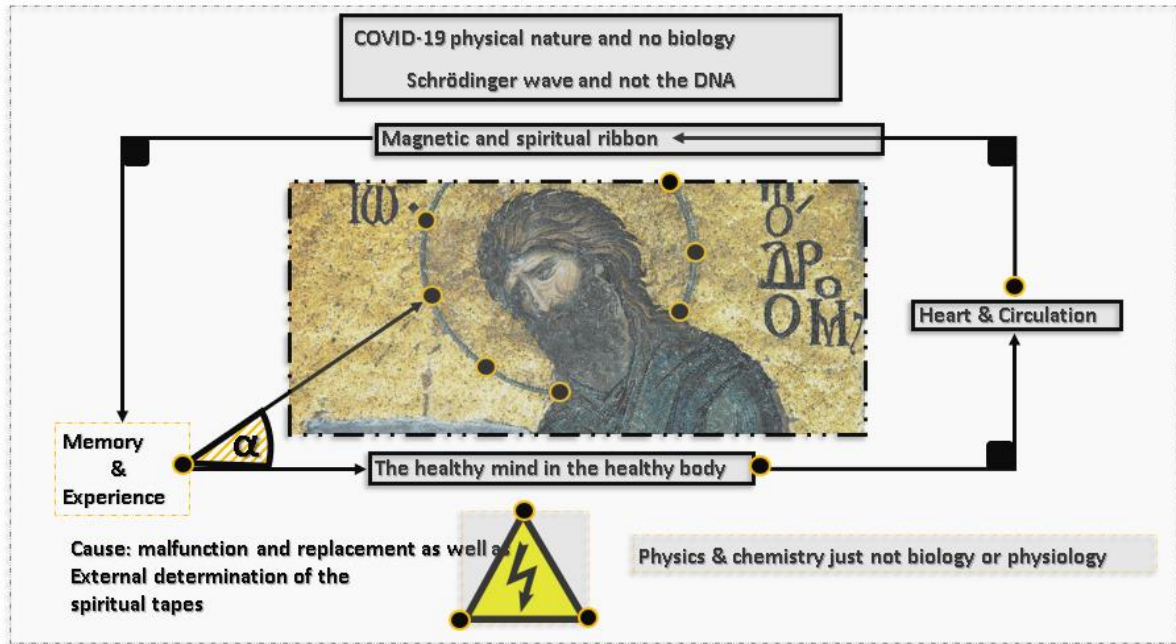

Figure 43: Alpha splitting of the mind by Covid-19 particles. Source: own illustration

It is only a matter of time before the topics covered in this work will lead mankind to realize that there is an afterlife, at least spiritually and dependent on memory.

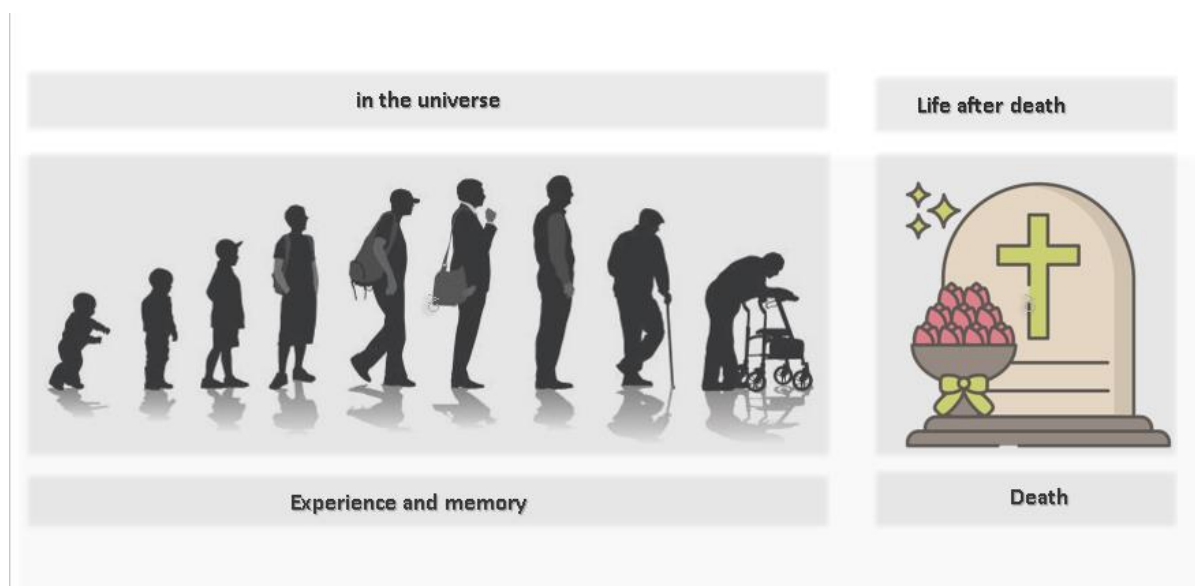

Figure 44: Life after death as new insights. Source: own illustration